

Panasonic®

REAL PRO *Elite*™

Household
Massage Lounger
Sillón de Masaje Doméstico
Fauteuil vibromasseur

Operating Instructions Instrucciones de Uso Mode d'emploi

Model/Modelo/Modèle No. **EP3513**



Before operating this unit, please read these instructions completely, and save for future reference.

Antes de utilizar esta unidad, lea completamente estas instrucciones y guárdelas para referencia futura.

Avant d'utiliser cet appareil, nous vous recommandons de lire l'ensemble de ces instructions et de les ranger dans un endroit accessible pour une consultation ultérieure.

INDEX

English

See pages 1- 39

INDICE

Español

Ver página S1- S39

INDEX

Français

Reportez-vous à la page F1- F39

IMPORTANT SAFETY INSTRUCTIONS

Basic precautions should always be followed when using an electrical unit, including the following.

Please ensure that you read all instructions before using the Household Massage Lounger.

DANGER – To reduce the risk of electric shock:

1. Always unplug the unit immediately after use.
2. Always unplug the unit before cleaning.

WARNING – To reduce the risk of burns, fire, electric shock, or injury to persons:

1. Always insert the power plug all the way into the outlet to reduce the risk of short-circuit and fire.
2. The unit should never be left unattended when plugged in. Always unplug the unit when not in use.
3. Close and continuous supervision is necessary when the unit is used by people who are limited in their ability to move or communicate.
4. Only use the unit for the purpose described in these instructions.
5. Do not stand on the unit.
6. Do not use any accessories other than those recommended by the manufacturer.
7. This unit should not be used by children. Keep children away from the unit. Always return the seat to the upright position and retract the legrest completely to avoid possible injury. Make sure that nothing is in the way when retracting the legrest. Remove key when not in use and store out of reach of children.
8. Never operate the unit if it has a damaged power cord or plug. Return the unit to the nearest authorized service center if it is not working properly, if it has been dropped or damaged, or if it has been immersed in water.
9. Always raise the back cushion to check that the fabric of the unit itself has not been ripped before using the unit. Please also check other areas to ensure that the fabric has not been ripped. No matter how small the rip, if you find one then immediately stop using the unit, unplug the power cord and have the unit repaired at an authorized service center.
10. Keep power cords away from heated surfaces. Do not carry the unit by the power cord. Do not allow pins, rubbish or moisture to come into contact with the plug.
11. Do not use the unit on top of heating appliances, such as electric carpets, etc. Do not operate the unit under blanket or pillow. Excessive heating can occur and cause fire, electric shock, or injury to persons.
12. Never block the air openings during operation and make sure that all air openings are kept free of lint and hair, etc. Do not drop or insert anything into any of the openings of the unit.
13. Do not use the unit in bathrooms or other damp or humid places as this may cause electric shock or cause the unit to malfunction. Do not spill water, etc. onto the control panel.
14. Do not use the unit outdoors.
15. Do not use the unit in places where aerosol spray products are in use or where oxygen is being used.
16. When unplugging the unit, turn off all controls before removing the plug from power outlet. Do not use the unit with a transformer as this may lead to malfunction or electric shock.
17. Connect this unit to a properly grounded outlet only. See Grounding Instructions.
18. To avoid electric shock or injury, do not attempt to open or disassemble any part of the unit as it contains no user-serviceable parts.

SAVE THESE INSTRUCTIONS

SAFETY PRECAUTIONS

WARNING: To avoid the risk of injury:

1. Persons with any of the conditions listed below or who are undergoing medical treatment should consult with their physicians before using the unit:
 - a) Pregnant women, people who are ill, in poor physical shape.
 - b) People suffering from back, neck, shoulder, or hip pain.
 - c) People who have a pacemaker, defibrillator, or other personal medical devices prone to electronic interference.
 - d) People suffering from heart disease.
 - e) People who are prohibited from receiving massage by a physician due to thrombosis or aneurism, acute varicose veins, or other circulatory disorders.
 - f) People with irregular curvatures of the spine.
2. Sit down slowly after checking the position of the massage heads. Never put any part of your body between the massage heads as the squeezing action of the massage heads may cause injury. Never put your fingers or feet in the gap between the backrest and seat, the backrest and the armrest, the seat and cover under the armrest, or the gap between the legrest and the footrest. Do not place your fingers or any part of your body in the mechanism below the legrest, or between the legrest and footrest.
3. Do not use the unit against bare skin. While thin clothing may increase effectiveness, exposing the skin directly to the massager may irritate the skin.
Do not use the unit while wearing anything hard on your head like a hair accessory, etc. Do not use the unit for massaging the head, abdomen, front neck, elbows or knees.
Do not use excessively strong massage action on the back of the neck.
4. When using the body scanning function, always ensure that the shoulder position is correct. If the shoulder position is not correct, use the Roller Position button to adjust it properly. You can adjust the shoulder position in this way in the pre-programs, self program and Rolling in the manual operation. Failure to align the shoulder position correctly can lead to injury.
5. Do not stretch the back muscles for more than approximately 15 minutes at a time. To avoid overstretching the muscles which may result in discomfort, do not use the unit for more than 5 minutes when first using it. You can gradually increase the duration and strength of the massage as you become used to it.
Do not massage any one point for more than 5 minutes at a time.
Excessive massaging can overstimulate the muscles and nerves and result in an adverse effect.
To prevent excessive massaging, do not use the massager for more than a total of 15 minutes each session.
After approximately 15 minutes, the massage heads will be retracted and stop moving.
The back cushion can be removed if you want to experience a stronger back massage. Exercise extreme care when you use this mode in order to avoid back pain or injury. Use only for short periods of time (no more than 15 minutes). Reinstall the back cushion if you want to restore to normal massage intensity.
6. While using the massager, if you start feeling sick or if the massage seems painful, stop using it immediately. While using the massager, if the pressure seems too strong, the movement of the massage heads can be stopped at any time by pressing the Quick Stop button.
7. Do not go to sleep while using the unit. Do not use the unit after drinking alcohol.
8. When the seat back is in a reclined position, do not sit on it or sit with your legs resting on the headrest. Do not sit on the legrest as the unit may fall over.
9. Do not allow children or pets to play on or around the unit, especially during operation.
10. Do not unplug the unit or turn it off during operation. Unplug the unit immediately if there is a power outage.
11. Be sure to start on the gentle massage program if using the massager for the first time. The shiatsu massage is stronger and should be enjoyed after one has gotten accustomed to the chair.
12. Do not allow children to play on this mechanized furniture or operate the mechanism. Legrest folds down on closing so that a child could possibly be injured. Always leave in an upright and closed position. Keep hands and feet clear of mechanism. Only the occupant should operate it.
13. Remove hard objects, such as false fingernails, wristwatches or rings, when massaging hands or arms. Empty pockets of hard objects when massaging the area of the seat or thighs.

OPERATING PRECAUTIONS

WARNING: To avoid damaging the chair, follow these precautions:

1. The chair is designed for a maximum user weight of 264 lbs (120 kg). Exceeding the maximum weight may cause permanent damage to the massage mechanism and/or other components of the unit. Any such damage is deemed to be user abuse and is not covered under the Limited Warranty.
2. Do not sit on or drop the control panel. Do not pull the control panel cord or the power cord. Be careful not to catch the cord of the control panel between the armrest and the chair back.
3. Do not treat the chair roughly, such as turning the chair on its side, turning the chair over or standing on it.
4. Do not treat the covering roughly.
 - Keep sharp or pointed objects away from the covering of the chair. Be careful not to drop lit ashes, lit cigarettes or matches on the chair.
 - Exposure to direct sunlight can cause fading or a change in color of the covering.
5. If the massager functions abnormally, immediately turn off the power and have the massager checked by an authorized service center.
6. Do not attempt to repair the massager yourself.
7. Do not repeatedly operate any switch at short intervals. Such action may cause the switch to malfunction.
8. Some noise may be heard coming from the massager while in use. This is due to the structure of the massager and is normal.
9. Make sure there are no obstacles behind the chair before reclining it. The chair can be reclined to a maximum angle of 170°. If the back hits a wall or pillar, the chair may malfunction. Be sure to have ample space behind the chair. Recline the chair slowly in order to avoid contact with an obstacle.
10. When excessive pressure is applied to the massage heads, they may stop moving for safety. When moving the heads up from the lowered position, one's body weight may stop the heads' movement. In such a case, slightly raise your body and allow the massage heads to move up.
11. After each massage, slide the power switch, which is located on the right side of the chair, to the "off" position and turn its lock switch to the "lock" position.
12. Do not sit on the chair with wet body or hair.
13. The unit must not be used in "wet rooms" (sauna, swimming pool) or outdoors.

GROUNDING INSTRUCTIONS

This product must be grounded. If it should malfunction or break down, grounding provides a path of least resistance for electric current to reduce the risk of electric shock. This product is equipped with a cord having an equipment-grounding conductor and a grounding plug. The plug must be plugged into an appropriate outlet that is properly installed and grounded in accordance with all local codes and ordinances.

DANGER

Improper connection of the equipment-grounding conductor can result in a risk of electric shock. Check with a qualified electrician or serviceman if you are in doubt as to whether the product is properly grounded. Do not modify the plug provided with the product – if it will not fit the outlet, have a proper outlet installed by a qualified electrician.

This product is for use on a nominal 120-volt circuit and has a grounding plug that looks like the plug illustrated in Figure A. Make sure that the product is connected to an outlet having the same configuration as the plug. No adapter should be used with this product.

Figure A

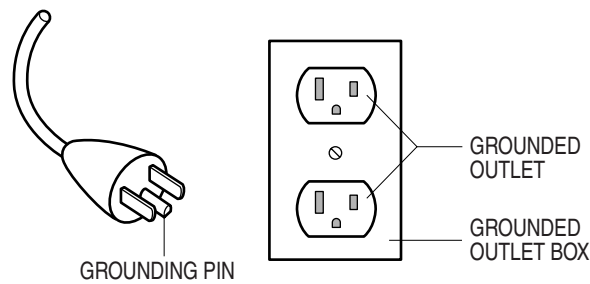

PART NAMES AND FUNCTIONS

MASSAGE LOUNGER

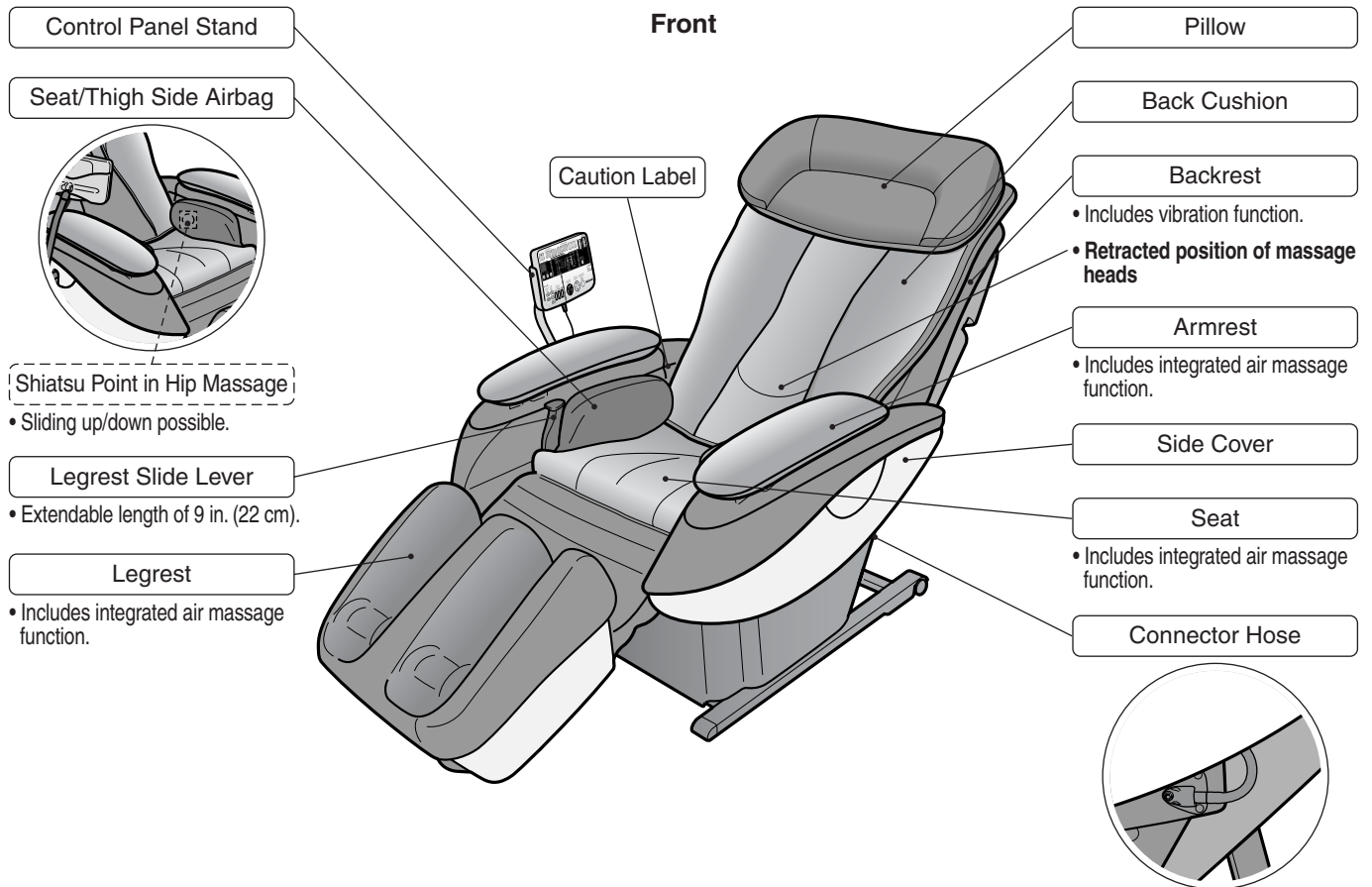

CONTROL PANEL

Cover Closed (Massage Programs Use)

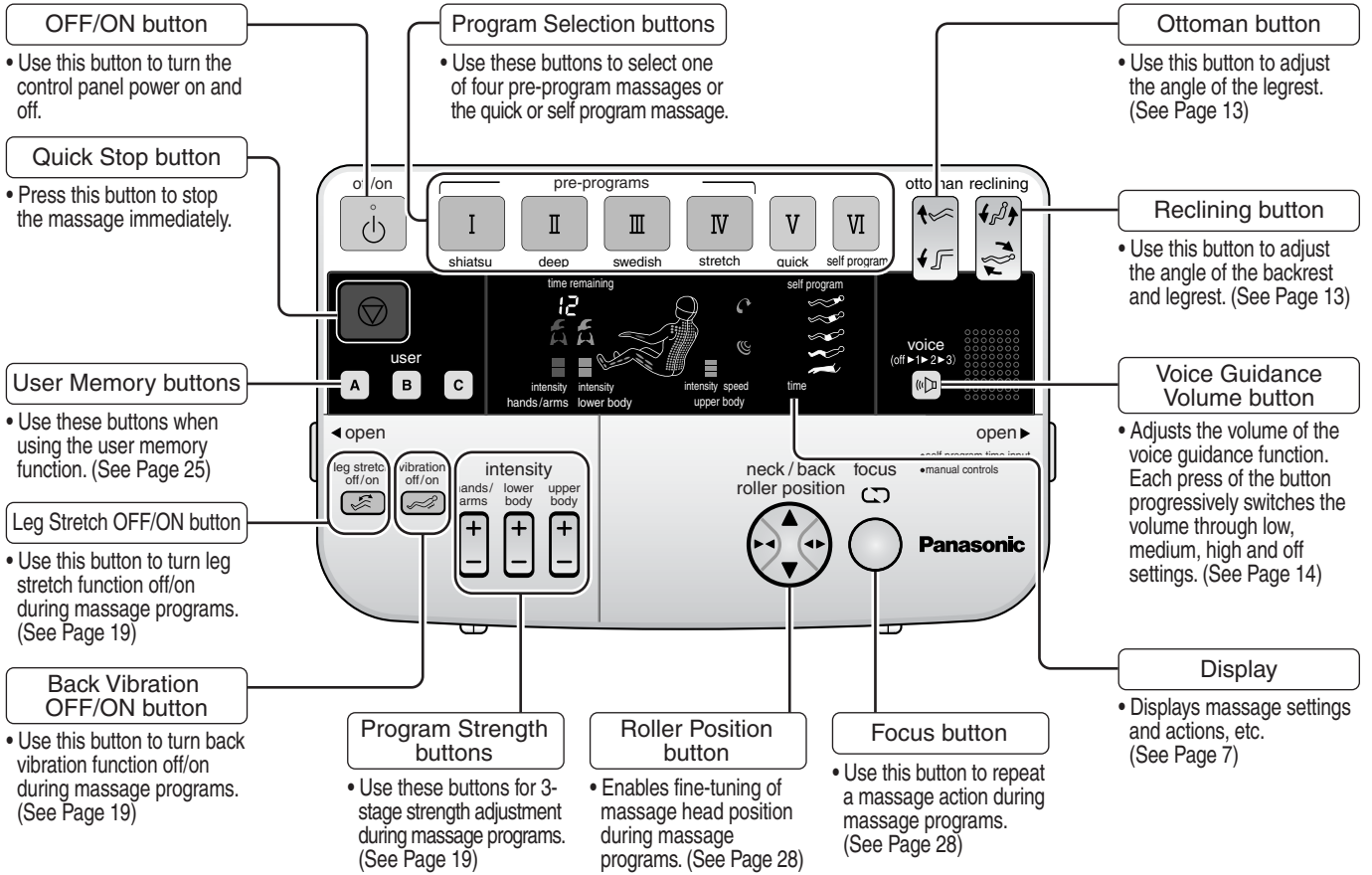

Cover Open (Self Program Settings and Manual Operation Use)

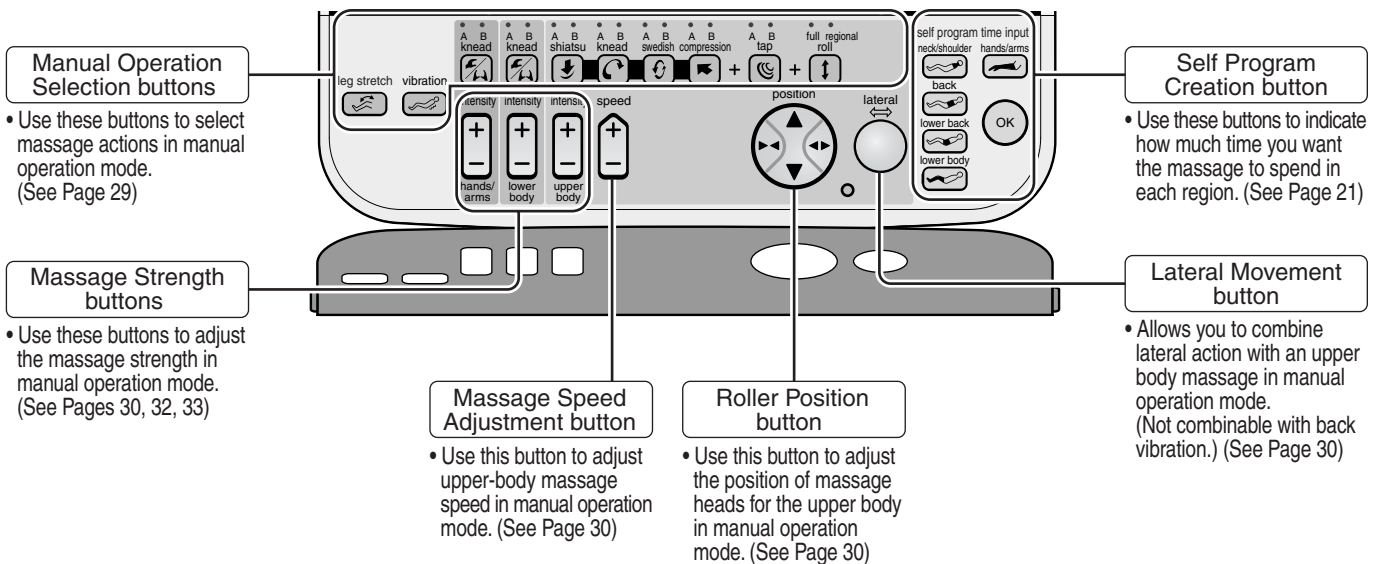

DISPLAY

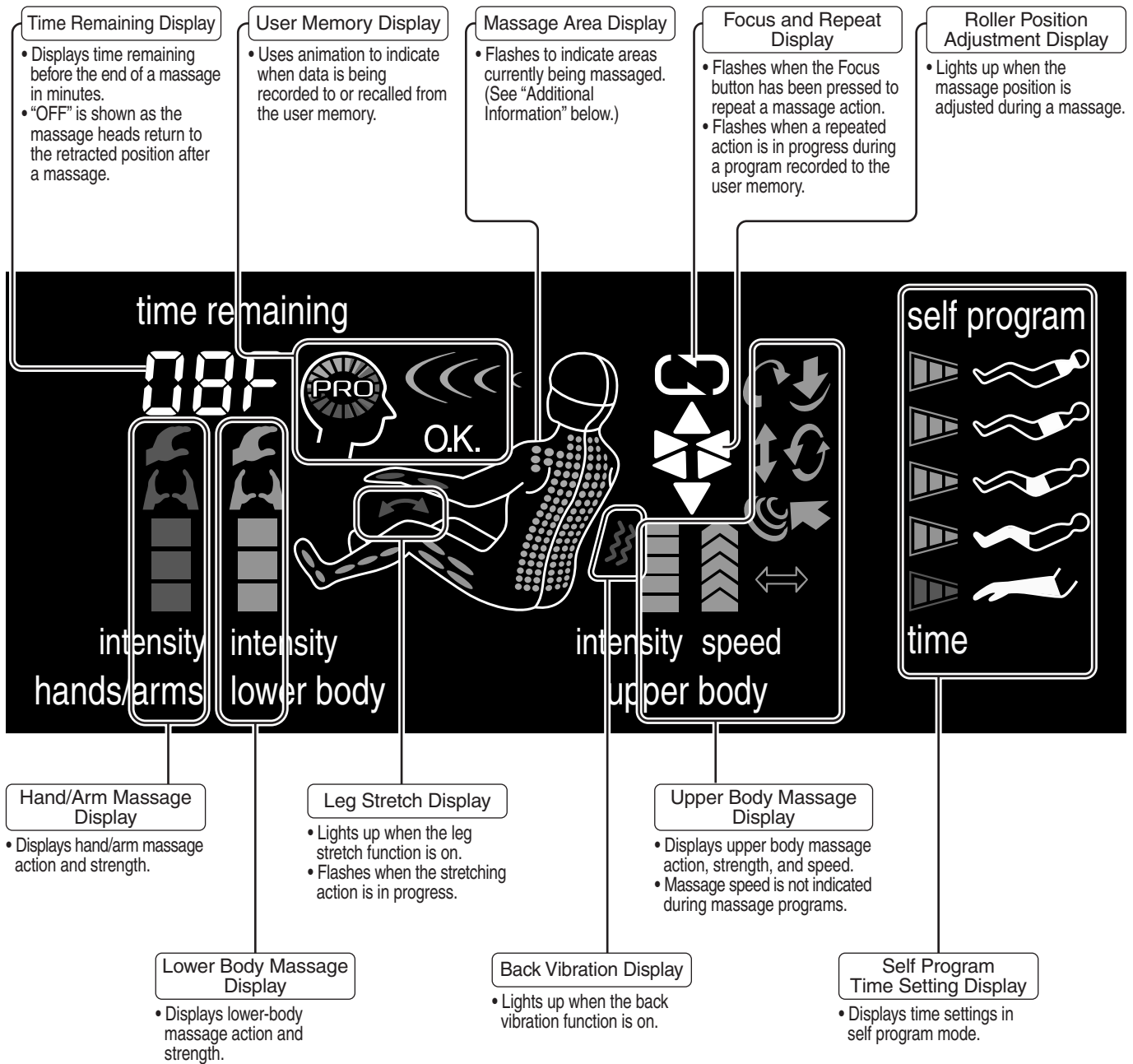

Additional Information

About the Massage Area Display

The massage area display can only show an approximation of the massage area. The area of massage shown by the massage area display may differ at times from the area you can feel actually being massaged.

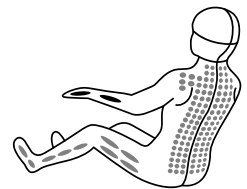

BEFORE USING THE UNIT

SETTING UP THE MASSAGE LOUNGER

After Removing Everything from the Box, You Should Have the Following

Massage Lounger

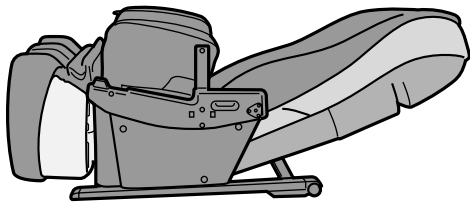

Armrests

Marks indicating left and right can be found on the underside of each armrest.

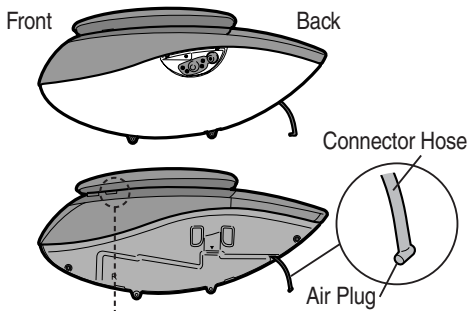

Small holes on the inside fabric are an intentional part of the functional design.

Accessories

Pillow

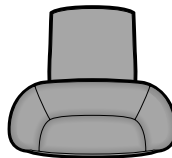

Attachment Screws (M6 x 16) — 6
 { Left Armrest — 3
 { Right Armrest — 3

Control Panel Stand Attachment Screws (M6 x 10) — 4

Plug Cover Attachment Screws (M5 x 16) — 2

Plug Covers — 2

Allen Key — 1

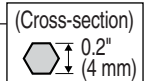

Control Panel Stand Covers

Lock Switch Keys — 2

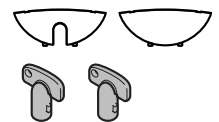

Where to Use the Unit

Ensure there is adequate space for reclining.

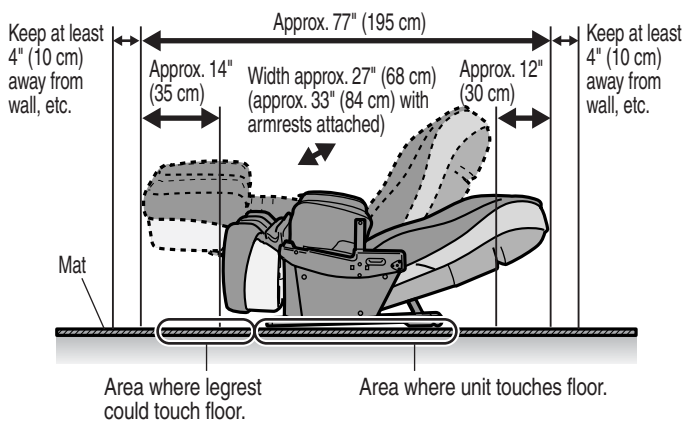

CAUTION

- Do not use the unit in areas with high humidity, such as the bathroom, etc. as this can lead to electric shock or other accidents.
- Place the unit on a totally flat surface. Failure to do so may result in the seat tipping over.
- Do not use the massage lounger in direct sunlight or in places where it will be exposed to high temperatures, such as in front of a heater, etc., as this can cause discoloration or hardening of the synthetic leather.
- Place the unit on a mat to prevent floor damage.
- When placing a mat under the unit, the size of the mat should be sufficient (at least 47 x 28 in. (120 x 70 cm)) to cover the areas where the unit touches and the legrest could touch the floor, as shown in the diagram on the left.

Carrying in the Unit

Move the chair by having one person hold onto the rubber section on the underside of the legrest and another person use the handle on the back of the backrest.

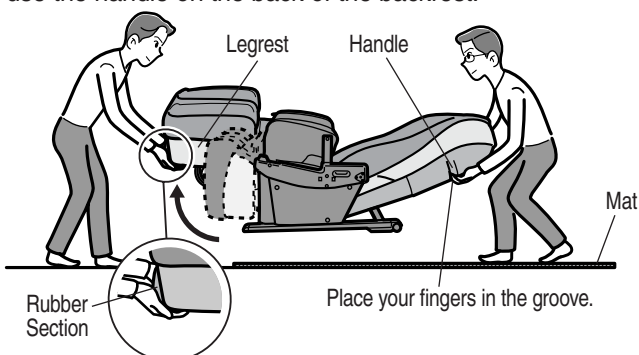

CAUTION

- Make certain the legrest has been retracted fully to its original length. Failure to observe this safeguard could result in injury due to the legrest returning to its original length when the unit is being moved.
- Use care to prevent pinching of hands or feet when letting go of the legrest as its mechanism will cause it to slam shut.
- Use care to prevent lower back and other injuries that could occur when lifting this heavy object (approx. 179 lbs (81 kg)).

ASSEMBLY

Attaching the Armrests (On Both Right and Left Sides)

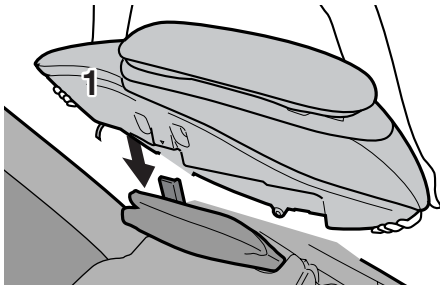

Use the ▼ mark as a guide for insertion.

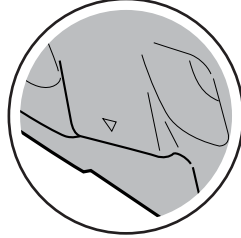

1. Insert the armrest into the unit.

- Markings indicating left-hand and right-hand sides can be found on the inside surface of each armrest.
- Make sure the control panel cord does not become pinched when fitting the right armrest onto the unit.

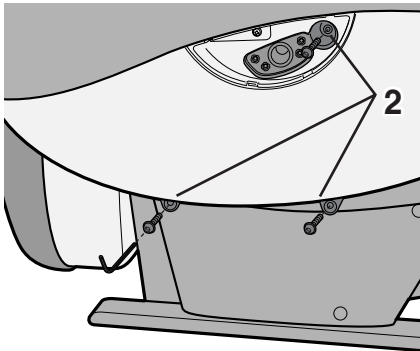

Turn screws clockwise to tighten.

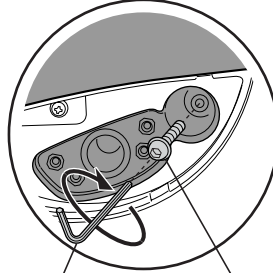

2. Fasten the armrest with the attachment screws.

- Set the three attachment screws in place first and then tighten them firmly.

Use This Screw

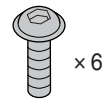

× 6

Allen Key
Attachment Screw (M6 × 16)

Connecting the Air Plugs (On Both Right and Left Sides)

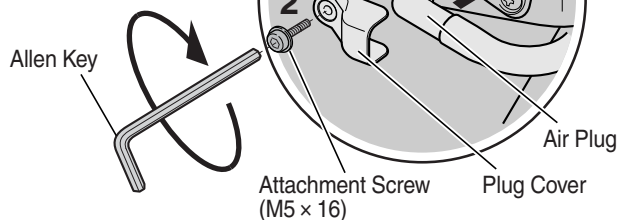
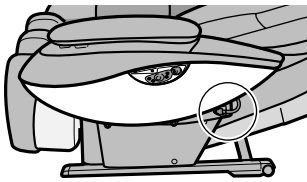

1. Insert the air plug.

- Push on the air plug until you hear it click into place.

2. Place the plug cover over top of the air plug and fasten with the screw.

Use This Screw

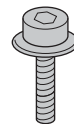

× 2

Allen Key

Attachment Screw (M5 × 16)

Air Plug

Plug Cover

Attaching the Control Panel Stand to the Right or Left Armrest

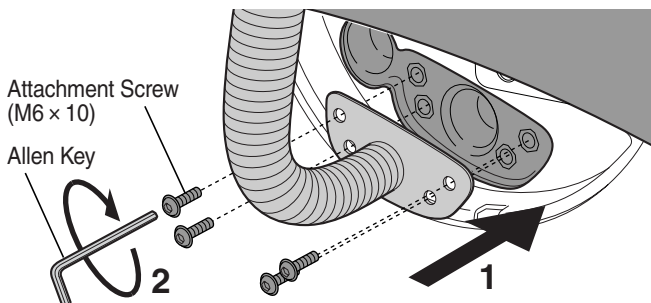

Attachment Screw (M6 × 10)

Allen Key

- Diagram shows attachment to right armrest.

1. Decide which side to attach the control panel stand to.

2. Fasten the control panel stand with the attachment screws in four places.

- Set the four attachment screws in place first and then tighten them firmly.

Use This Screw



× 4

Attaching the Control Panel Stand Covers (On Both Right and Left Sides)

Cover for Side WITH Control Panel Stand

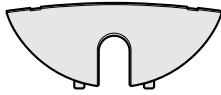

Cover for Side WITHOUT Control Panel Stand

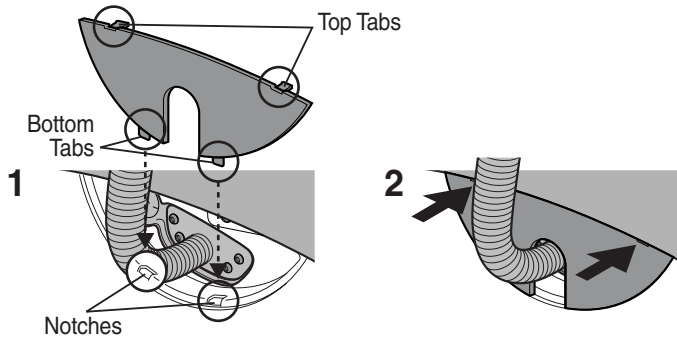
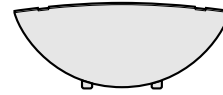

The method of attaching the covers is the same for both sides.

- Diagram shows side attached with control panel stand.

1. Insert the bottom tabs on the cover into the notches on the armrest.
2. Insert the top tabs on the cover into the notches on the armrest.

When Removing the Control Panel Stand Covers

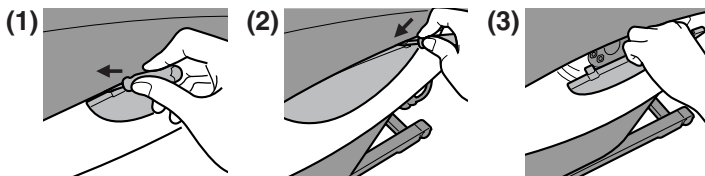

- (1) Insert the head of a flat-tip screwdriver between the top tabs of the cover.

- Performing this procedure with the Allen key or a cross-point screwdriver could damage the unit.

- (2) Pull out the top tabs of the cover (two places) using the flat-tip screwdriver.

- (3) Pull up on the cover at an angle.

Attaching the Pillow

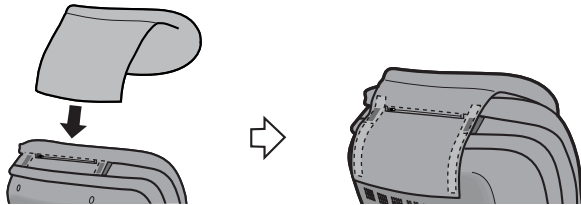

Use the pillow fasteners to attach the pillow.

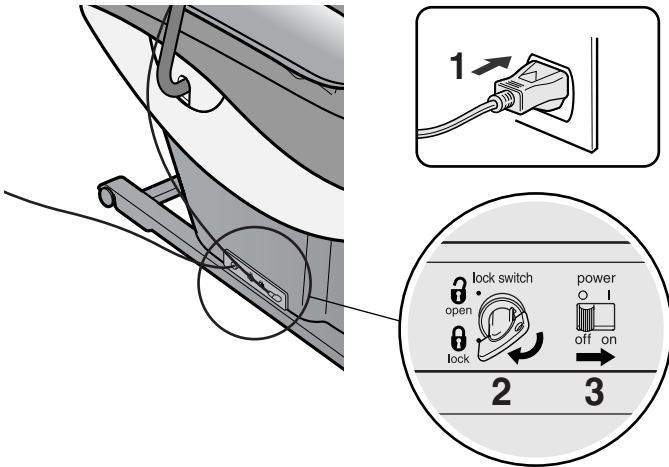

Raising the Backrest to the Upright Position

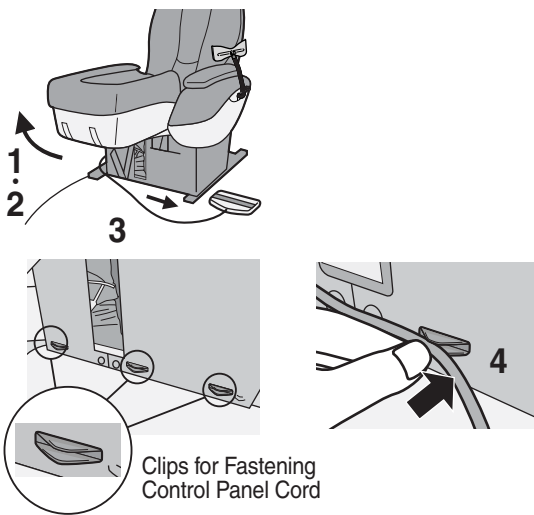

1. Insert the power plug into the power outlet.
2. Insert the key and turn the key lock to the “open” position.
3. Slide the power switch to the “on” position.
4. Press  on the control panel twice.
 - The backrest will rise to the upright position automatically.

Moving the Control Panel Cord to the Left Side (When Control Panel Stand is on Left Side)



1. Press  on the control panel to turn on the power.
2. Press  on the control panel and hold until the legrest has risen as far as it will go.
 - Continue pressing until a “beep-beep-beep” sound is heard.
3. Move the control panel cord under the legrest to the left side.
4. Fasten the control panel cord at three points.

Placing the Control Panel into the Control Panel Stand

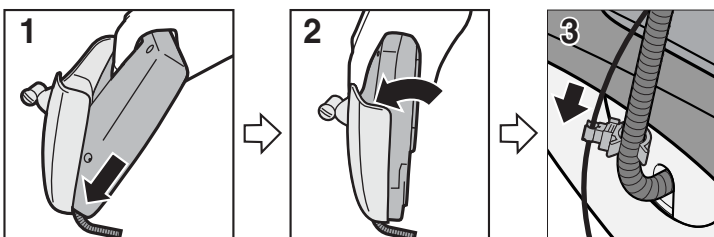

1. Insert the control panel at an angle into the tabs on the control panel stand.
2. Push the control panel into the control panel stand.
3. Fasten the control panel cord using the clip.

To remove the control panel, slide it upwards.

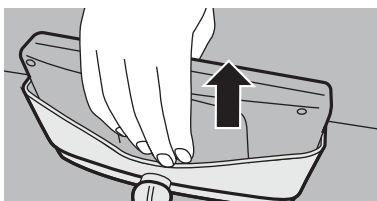

For smooth removal of the control panel, press on the back of the unit while sliding up.

BEFORE SITTING DOWN

Please Check the Following Before Using the Unit

Check the Surrounding Area

- (1) Check that there is nothing around the unit.
- (2) Check that there is enough room (15.7 in. (40 cm)) to recline the unit.

Lower the Legrest Prior to Sitting Down

- Do not sit down when the legrest is raised. Doing so may result in injury due to the chair tipping over.

To lower the legrest...

Pull the legrest slide lever, make sure the legrest is fully retracted, then press  twice to return the legrest to its lowest position.

ADJUSTING THE SEAT

Adjusting the Reclining Angle

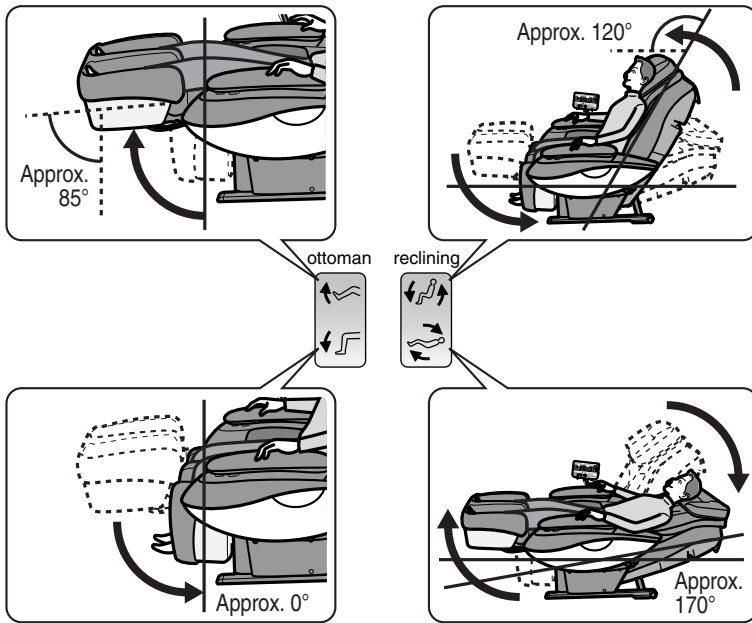

1. Press to turn on the power.

2. Press or to adjust the angle of the backrest and/or legrest.

- Movement will continue until a “beep-beep-beep” sound is heard if the buttons are held down.
- The legrest will start to move shortly after the backrest.
- During a lower body massage, the legrest cannot be positioned at a level lower than that of the correct massage position. (See Page 16)

Extending the Legrest

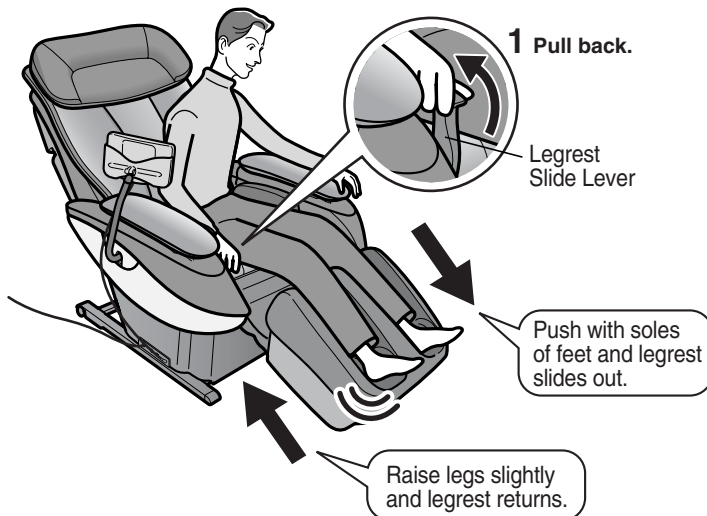

1. Slide the legrest out to the desired position while pulling the legrest slide lever.

(Extendable length of 9 in. (22 cm))

2. Release the legrest slide lever.



Release the lever.

Legrest Slide Lever

Adjusting the Pillow for Correct Height During a Massage

Adjust the height of the pillow so that the bottom edge is at ear level.

- If positioned too low, the pillow may interfere with massage of the area around the neck.

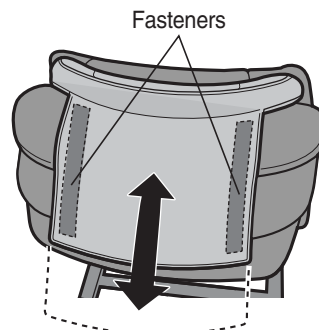

ADJUSTING THE VOICE GUIDANCE VOLUME AND THE CONTROL PANEL STAND

Adjusting the Voice Guidance Volume

voice
(off ▶ 1 ▶ 2 ▶ 3)

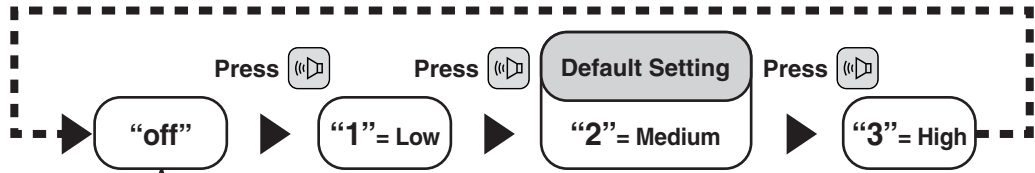

The single beep (when a button is pressed) and the triple beep (when the adjustable setting limit is reached) are still audible.

Adjusting the Control Panel Stand

The arm section bends to allow positioning towards the front or the rear.

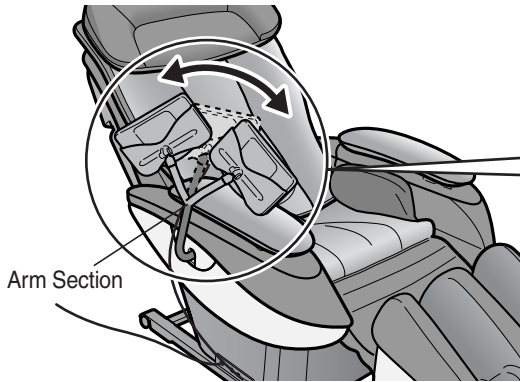

The control panel can also be rotated sideways or tilted backwards when in the control panel stand.

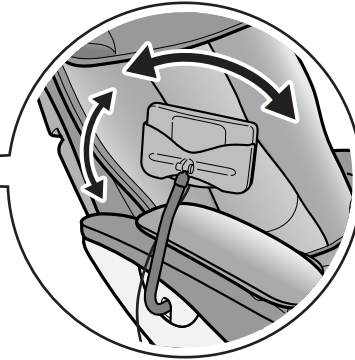

USING THE MASSAGE LOUNGER

USING THE PRE-PROGRAM AND QUICK MESSAGES – Basic Usage

Recommended when you want a complete massage.

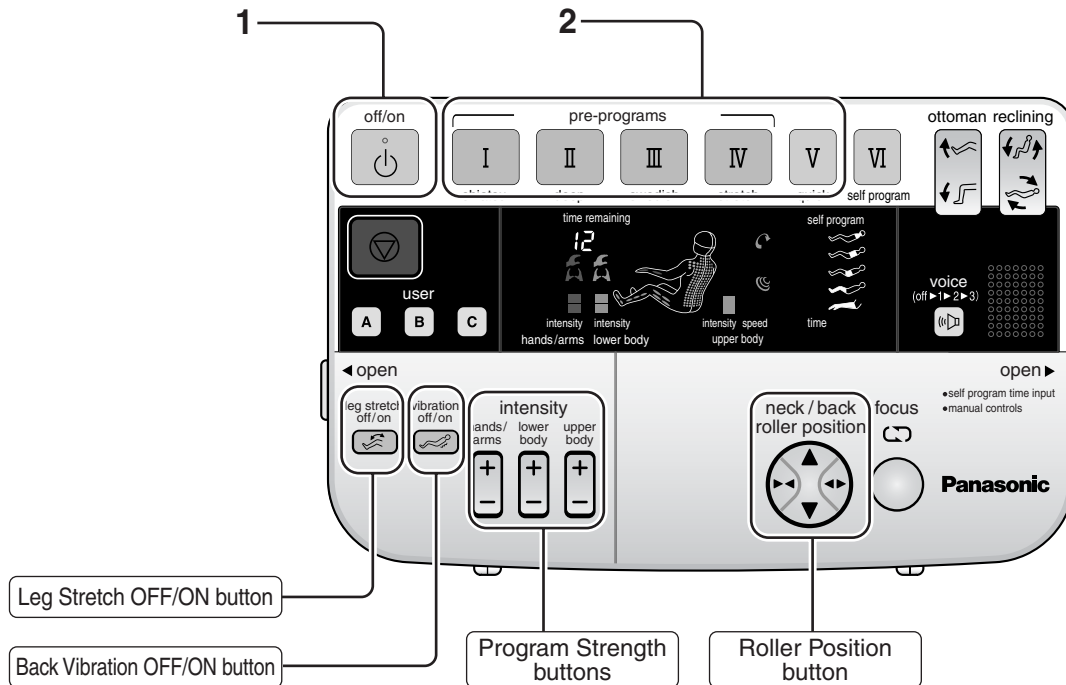

Additional Information

Pre-Program and Quick Massage Characteristics (Upper Body)

• For an overview of each massage program, please refer to the additional information on page 20.

- | | |
|---|--|
| <p>I Shiatsu: Uses mainly shiatsu massage to loosen up deep-seated knots of tension. Recommended for those with severe stiffness and tension.</p> | <p>II Deep: Uses mainly kneading to manipulate and loosen muscles. Recommended for those with mild stiffness and tension.</p> |
| <p>III Swedish: Uses mainly Swedish massage to gently invigorate and promote circulation. Recommended for those experiencing fatigue and weariness.</p> | <p>IV Stretch: Uses mainly compression to slowly stretch out muscles and joints. Recommended when a refreshing stretch is desired.</p> |
| <p>V Quick: Covers all areas using a variety of massage actions in a span of just five minutes. Recommended for those who want to relax quickly.</p> | |

1. Press to turn on the power.

• The massage heads will remain stationary until a massage program is selected.

These buttons will flash.

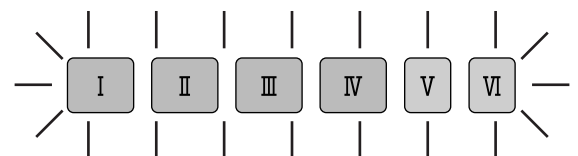

2. Press one of the flashing buttons (I , II , III , IV or V) to select a program.

- The body scanning will commence when the program is selected. (See Page 36)
- The body height range that can be properly detected by the body scanning is between approximately 4.6 and 6.1 ft. (140 and 185 cm).

- The unit will automatically recline to the correct massage position.

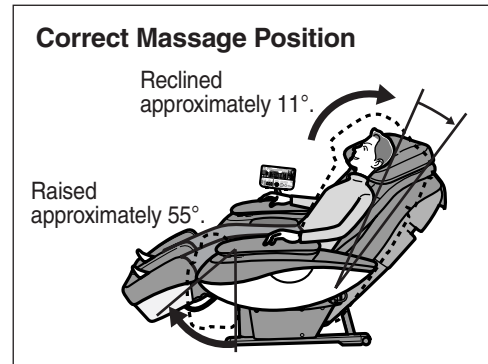

- If the massage lounger is reclined further than this angle, it will not automatically return to the correct massage position.

Body scanning lasts for approximately 30 seconds.

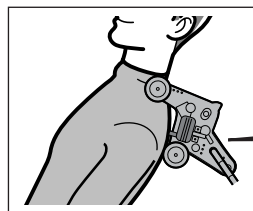

A soft tapping action begins to determine your shoulder position.

3. Confirm the shoulder position has been correctly determined according to the position where the soft tapping is carried out.

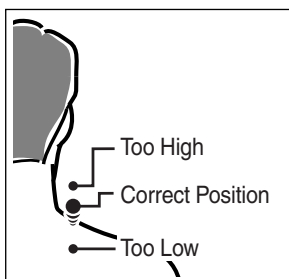

Adjust the position so that the underside of the massage heads is lightly touching the tops of your shoulders.

When the shoulder position is incorrect...

neck / back roller position



Adjust the position of the massage heads, **while the soft tapping is in progress**, using the Roller Position button to move the massage heads up or down.

A single press of the button will raise or lower the massage heads approximately 0.5 in. (1.2 cm).

The massage will commence after the body scanning has been completed.

- Air massage of the lower body and hands and arms commences simultaneously with the soft tapping.
- Leg stretch and back vibration functions are also in operation.

Automatic adjustment of the angle of the legrest may also occur.

The legrest adjusts to four angles so that the soles of the feet touch the footrest wells according to a rough estimate of occupant height based on the shoulder position.

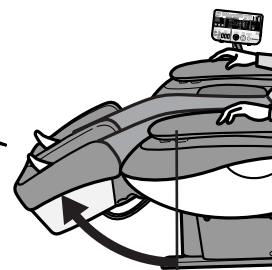

4. Adjust the length of the legrest when the backs of your calves or knees are not resting in the legrest wells.

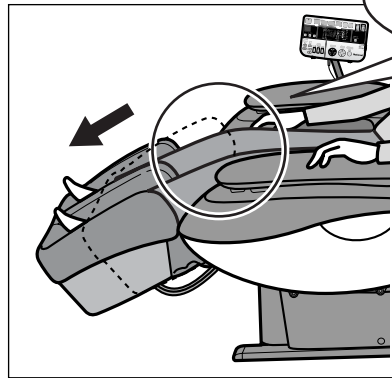
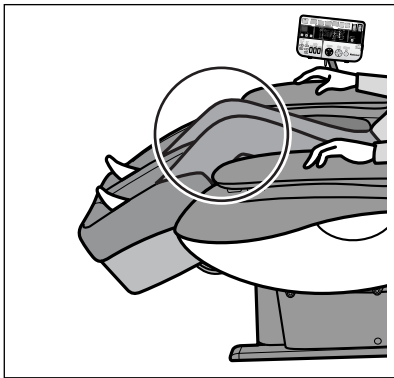

Pull the legrest slide lever to adjust the length of the legrest. (See Page 13)

5. Open the lift-up portion of the armrest and insert your hand and forearm.

CAUTION

- Remove hard objects, such as false fingernails, wristwatches or rings, when massaging hands or arms. Failure to do so may result in injury.

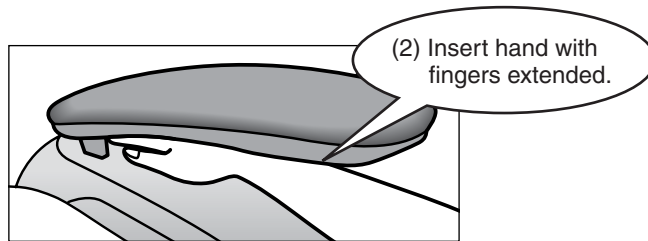
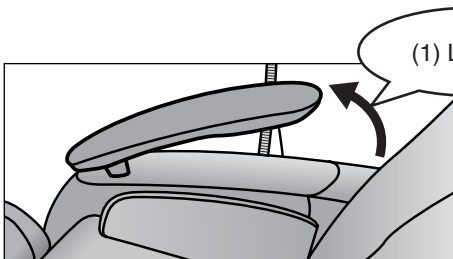

Hand/Arm Position

Position the forearm and hand at the center of the armrest.

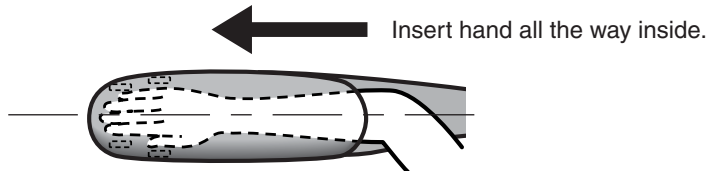

Note: Raise backrest if difficulty is experienced when positioning hand and forearm.

6. When the massage is finished the unit will automatically shut off.

I II III and IV last approximately 15 minutes.

V lasts approximately 5 minutes.

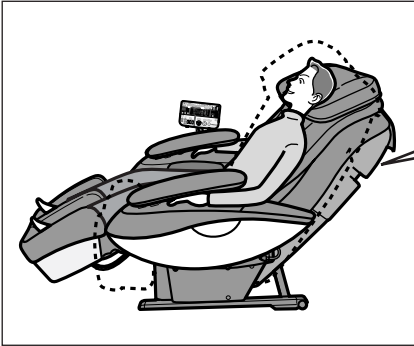

The unit will remain in the reclining position of the massage when it shuts off.

Press  twice to return the backrest and legrest to the upright position.

Note: The backrest and legrest may stop mid-way if an occupant cannot be detected.

To stop mid-way through a massage, press .

- The massage heads will return to the retracted position.
- The backrest and legrest will automatically return to the upright position.

Note: The backrest and legrest may stop mid-way if an occupant cannot be detected.

To immediately stop the massage, press .

- All operations will stop immediately.
- The chair will remain in the exact position it was in when the button was pressed.

When the unit switches off...

 will flash, indicating that the unit is in user memory data saving mode.

- When no data has been recorded there is no need to press any buttons. The unit will switch off after approximately 10 seconds.
- When the massage is ended by pressing , the unit will not go into the data saving mode.
- Please see pages 23 through 25 for details on how to use the user memory function.

USING THE PRE-PROGRAM AND QUICK MESSAGES – Adjusting to Your Preference

Adjusting Massage Strength

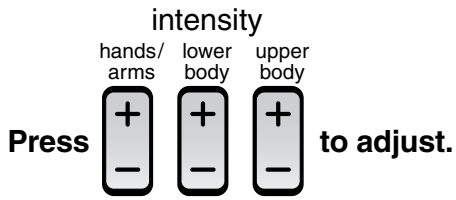

- Lower body and hand/arm massages will stop when set to zero.

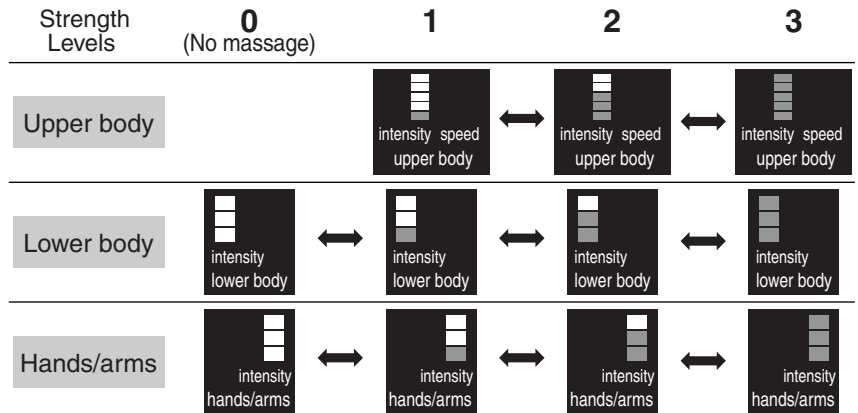

Turning Back Vibration and Leg Stretch Functions Off and On During a Program

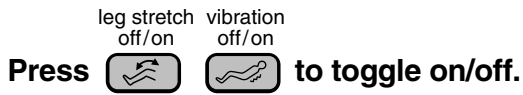

The display will indicate whether leg stretch and back vibration functions are turned on or off. (Lit areas indicate active functions. Unlit areas indicate inactive functions.)

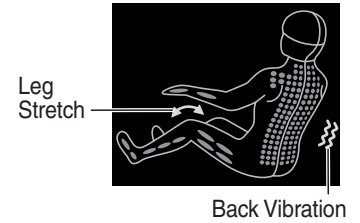

Additional Information

Overview of Pre-Program and Quick Massages (Upper Body)

Shiatsu Program (I)

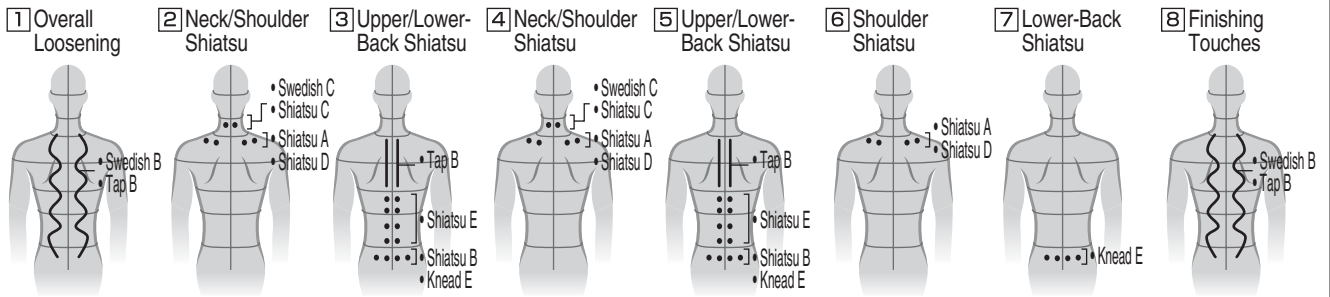

Deep Program (II)

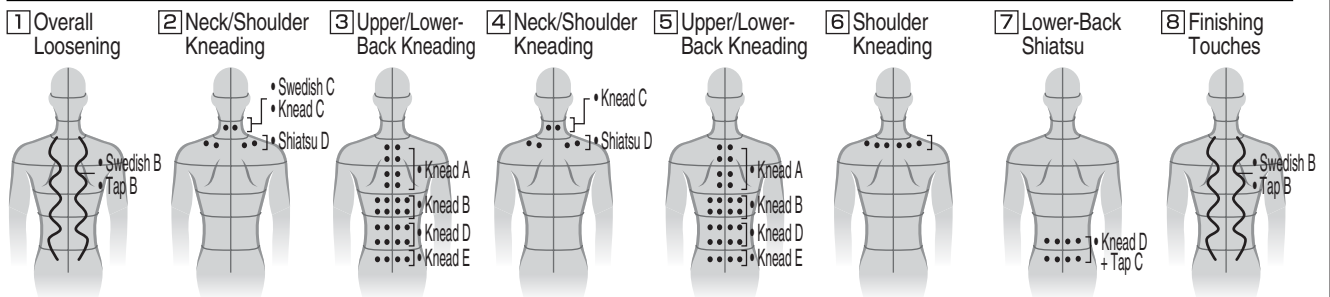

Swedish Program (III)

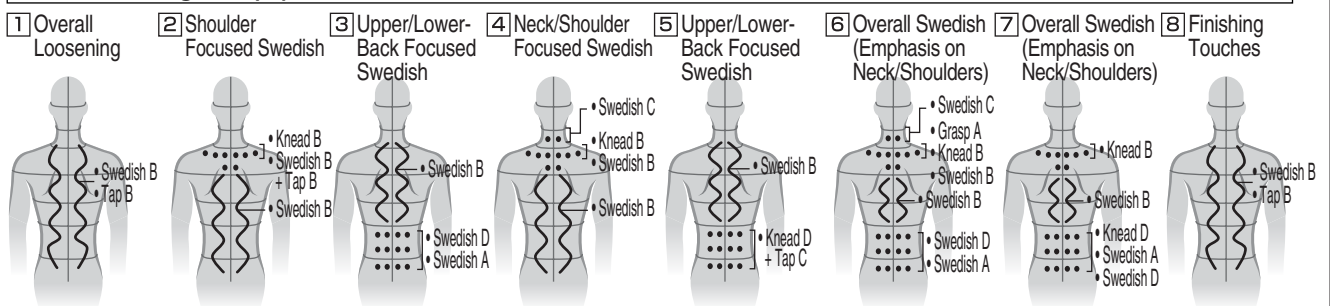

Stretch Program (IV)

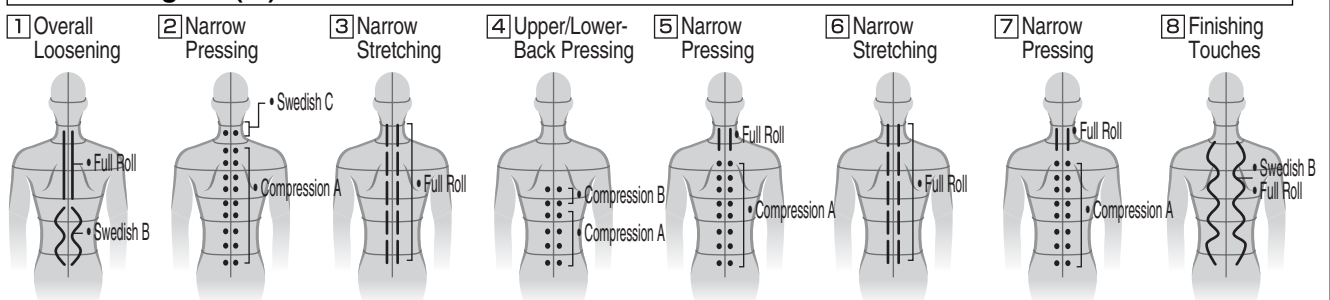

Quick Program (V)

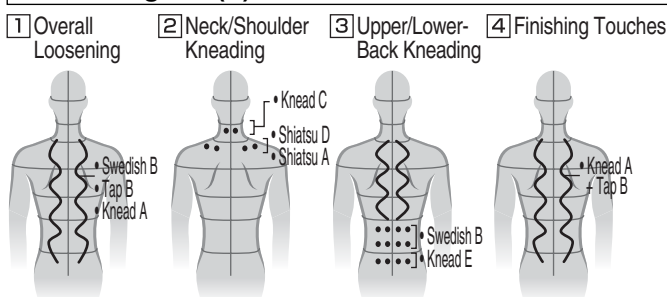

USING THE SELF PROGRAM – Basic Usage

Recommended when certain areas of your body are more fatigued than others.

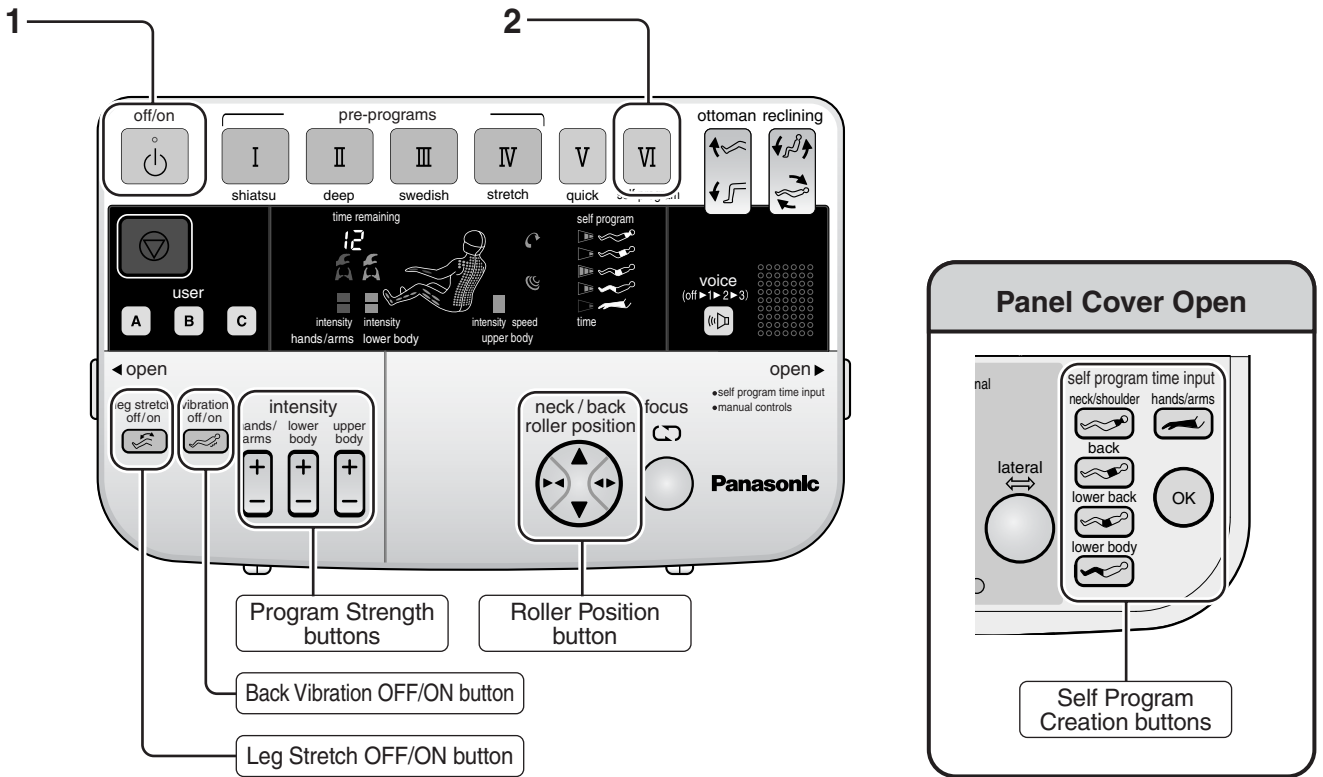

Reference

Setting Examples for Self Program

(A), (B) and (C) below are provided as examples of how you can use the self program to create a massage using different time settings for different parts of your body.

(A) “My neck and shoulders are always particularly stiff, so I’ll focus the massage on my neck and shoulders.”

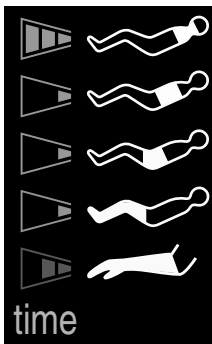

Setting Example

(B) “My upper back and lower back are the only parts that feel tired today, so I’ll just massage my upper and lower back.”

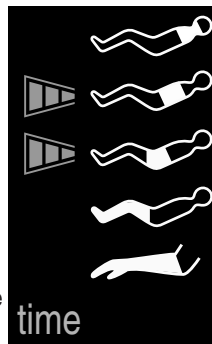

Setting Example

(C) “I’ve had a pre-program massage, but now I’d like to massage just my legs for awhile.”

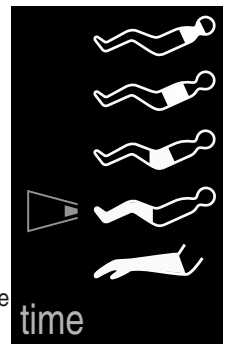

Setting Example

1. Press to turn on the power.

- The massage heads will remain stationary until a massage program is selected.

These buttons will flash.

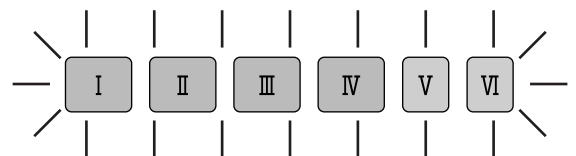

2. Press .

The display will flash.

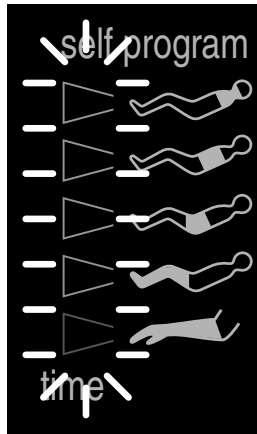

3. Open the cover and input the time settings.

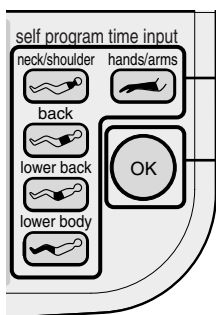

(1) Set the time for each area of the body.

- The time will change, as shown below, according to the number of times pressed.



(2) Press  after completing settings for each body area.

- The selected program will be configured to reflect your time settings.

4. Close the cover.

- If the cover is left open, you will be unable to use the Leg Stretch OFF/ON, Back Vibration OFF/ON, Program Strength or Focus buttons during the massage.

From this point on the instructions for operation are the same as those for those once a massage program is selected, as covered starting from step 2 of page 16.

Strength adjustment, on/off switching of leg stretch and back vibration functions are performed in the same way. (See Page 19)

- The duration of a massage in the self program mode is approximately 15 minutes.
- Body scanning is not performed when all time settings for the upper body are set to zero. Upper-body vibration will also be inactive in this case.
- If time settings for the lower body are set to zero, the massage will commence with leg stretch function set to off. This function may be turned on by pressing the Leg Stretch OFF/ON button.

USING THE SELF PROGRAM

Changing Time Settings Part Way through a Massage

1. Open the cover and input the time settings.

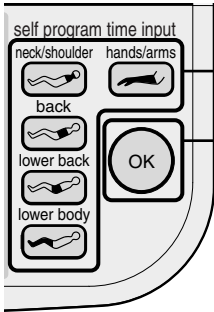

(1) Open the cover and input the time settings you want to change.

(2) Press **OK** after completing setting adjustments.
The program will be reconfigured to reflect the change(s) made to settings.

2. Close the cover.

- If the cover is left open, you will be unable to use the Leg Stretch OFF/ON, Back Vibration OFF/ON, Program Strength or Focus buttons during the massage.

Advanced Usage

Saving Time by Recording Time Settings

Recording Time Settings

After the massage finishes or  is pressed to finish the massage, proceed as follows.

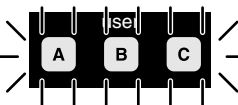
When the  buttons flash...

Press the User Memory button you want to record your settings to.

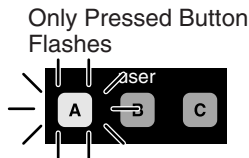

Recording Complete

When the Selected Button Flashes Rapidly

Rapid Flashing

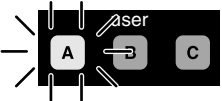

- This indicates that settings have already been recorded using that User Memory button. To record over the existing data, press the same button once more. (The existing data will be deleted.)
To keep the existing data, press another User Memory button.

Beginning a Massage Using Recorded Time Settings

(1) Press .

(2) Press the button used to record your data.



(3) Press .

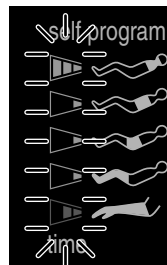

- The recorded time settings will be displayed.

The program with the recorded time settings will begin immediately.

Changing Recorded Time Settings

 See "Changing Time Settings Part Way through a Massage" above.

Additional Information

About the Time Settings in Self Program

- The type and duration of massage actions in self program are determined according to different areas of the body based on the time settings.

Order of Massage for Upper Body

- Areas are massaged in order of the longest to the shortest time setting.
- When two areas are set to the same time setting, the massage will proceed in order of the neck and shoulders, the upper back and the lower back areas.

Order of Massage for Hands/Arms and Lower Body

- Massaged in order of lower body then hands and arms, regardless of time settings.

When the Time Setting is Zero

- An area of the body set at zero will not receive any massage. In the case of the upper body, however, the massage heads may travel over that area as they move to the next massage area.
- The upper body will not receive any massage when all settings for the upper back, lower back, and neck and shoulders are at zero.

Additional Information

Overview of Massages in the Self Program

Neck/Shoulders

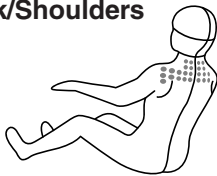

Uses mainly Shiatsu A to undo knots of tension.



Uses mainly Knead B to manipulate and relax muscles.



Uses mainly rubbing actions like Swedish B to gently massage and alleviate fatigue.

Upper Back

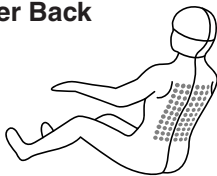

Uses mainly Shiatsu E to undo knots of tension.



Uses mainly Knead A and Knead B to broadly manipulate and relax muscles.



Uses mainly rubbing actions like Swedish A to gently massage and alleviate fatigue.

Lower Back



Uses mainly Shiatsu E and Knead E to undo knots of tension.



Uses mainly light, penetrating actions to briskly loosen muscles.



Uses mainly rubbing actions like Swedish D to gently massage and alleviate fatigue.

Lower Body



Uses mainly slow, powerful actions to vigorously loosen muscles.



Uses mainly light, penetrating actions to briskly loosen muscles.



Uses mainly strong upward strokes to promote circulation and alleviate tiredness.

Hands/Arms

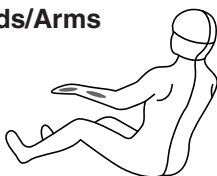

Uses mainly rhythmic loosening actions to thoroughly relax muscles.



After using rhythmic loosening, thorough kneading is used to promote circulation.



Uses mainly strong upward strokes to promote circulation and alleviate tiredness.

ADVANCED USAGE WITH THE USER MEMORY FUNCTION

A function that allows you to create customized programs for massages better suited to your needs.

Change and record message programs according to your preference.

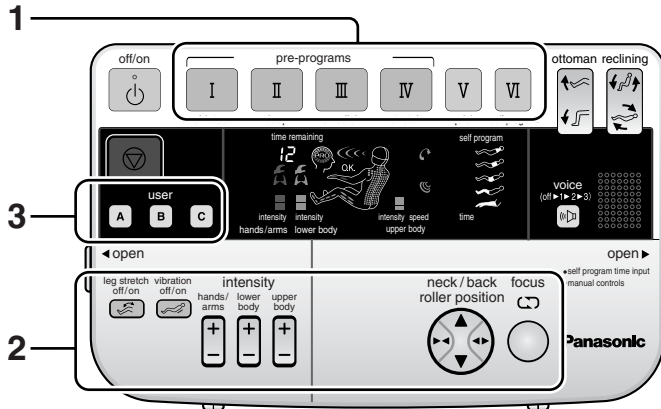

1. Begin a message program as described on pages 15 to 22.

- Select one of the pre-program messages or the quick or self program message.

2. Making adjustments to your liking during the massage.

When you find a spot that feels good...

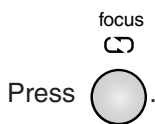

Animation on Controller Display



Flashes when action repeated.

- The massage action in progress when the button is pressed is repeated.
- The same action at the same position within the program is repeated.
- The program is modified to increase the massage action at the point on the body when the button was pressed.

When the position of the massage heads is a little off...

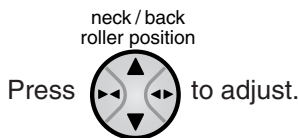

Animation on Controller Display



Adjusted direction flashes.

- The orientation of the massage heads touching the body is adjusted. (See page 28 for the adjustable range.)
- The massage heads automatically shift to the same position they were adjusted to within the program.
- The adjustment is also reflected in other massage programs.

3. Record the adjustments you have made.

After the massage finishes or is pressed to finish the massage, proceed as follows.

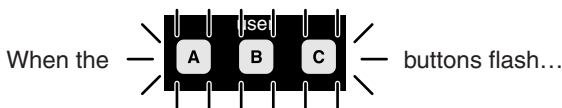

Press the User Memory button you want to record your settings to.



Only Pressed Button Flashes

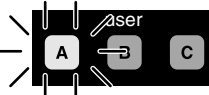

Recording Complete

Animation on Controller Display



When the Selected Button Flashes Rapidly

Rapid Flashing

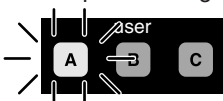

- This indicates that settings have already been recorded using that User Memory button. To record over the existing data, press the same button once more. (The existing data will be deleted.)
- To keep the existing data, press another User Memory button.

Additional Information

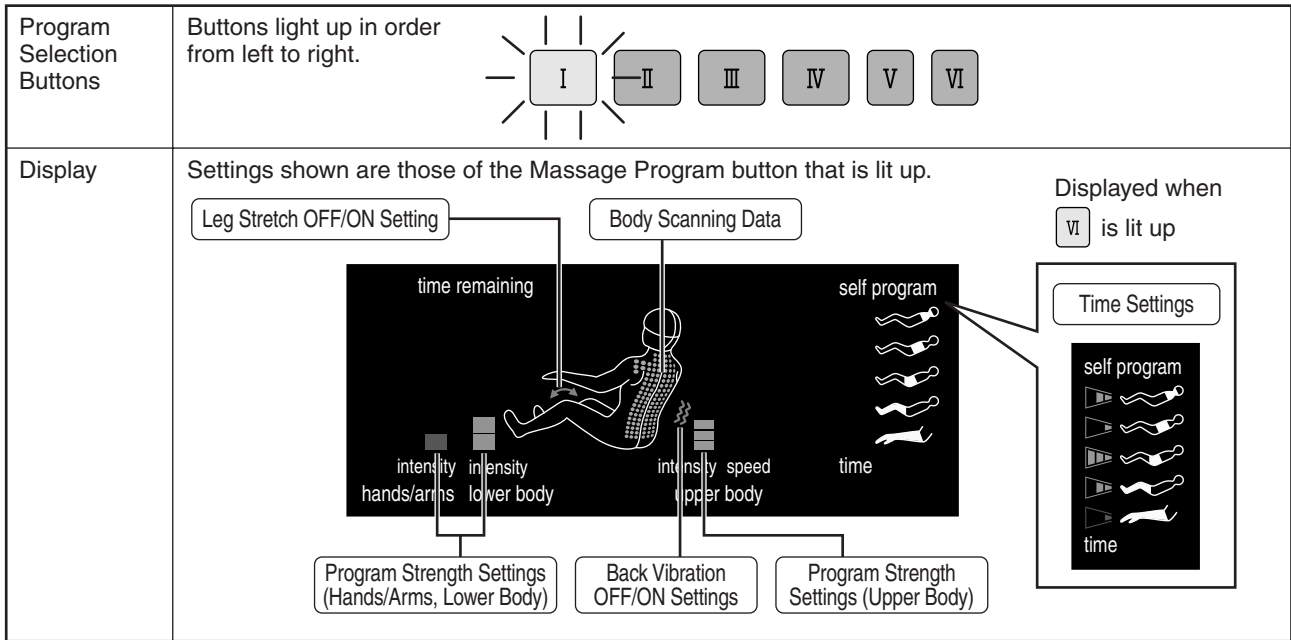

About Recorded Massage Settings Shown on the Display

- The settings you record after a massage finishes or  is pressed to finish a massage are displayed on the control panel.
- Setting adjustments shown on the display do not indicate changes made to recorded settings unless the above procedure has been performed (“3. Record the adjustments you have made.”).



The volume setting of the voice guidance is also recorded.

Record changes made to individual settings during a massage program.

- Settings can be recorded when the program finishes or  is pressed to finish the massage. (Setting changes cannot be recorded when the program is finished by pressing  or when the changes to settings were made in manual operation.)
- Setting changes are recorded in the same way as described in “Change and record massage programs according to your preference.”

Recordable Settings

- Settings are divided between those that are recorded for individual programs and those that are recorded as settings shared by all programs.

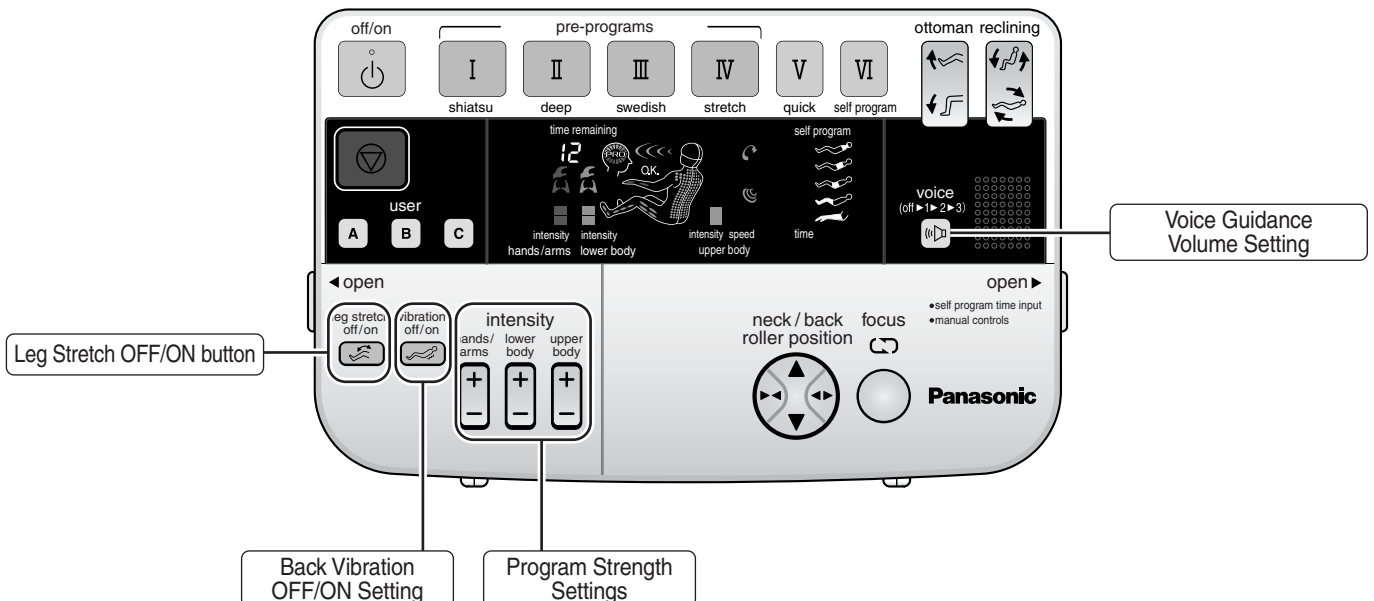

When You Want to Use Your Recorded Massage Settings

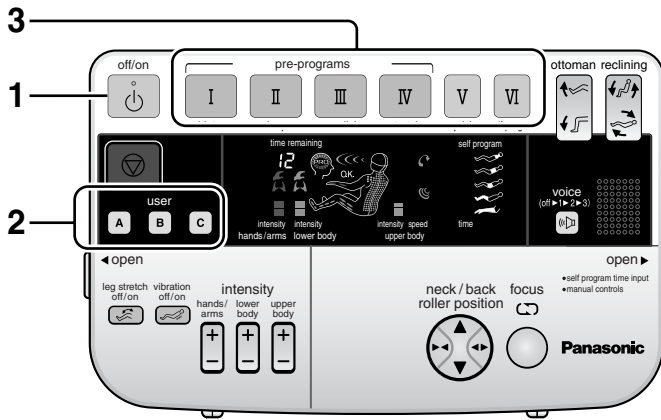

1. Press  to turn on the power.

2. Press the button used to record your data.

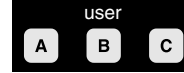

3. Press one of the flashing buttons (, , , ,  or ) to select a program.

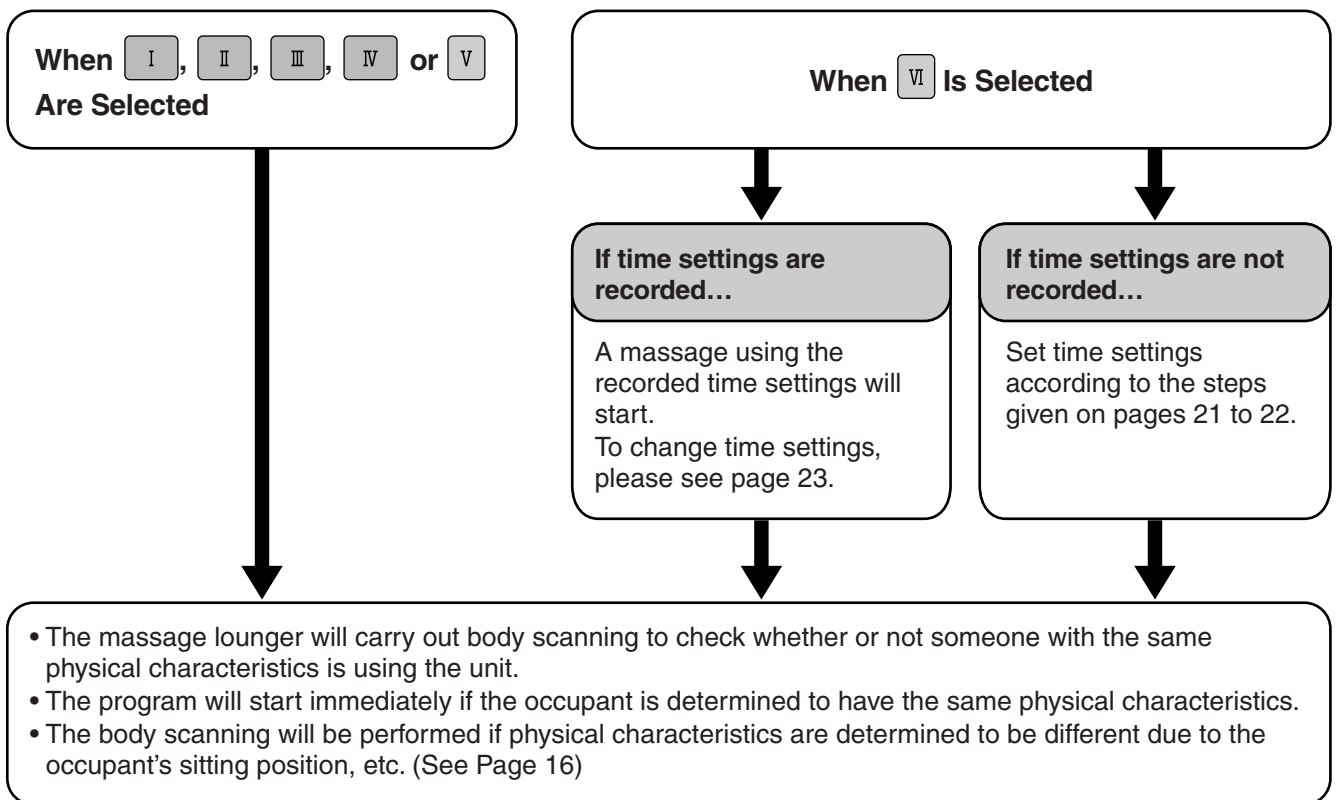

Creating a Customized Program

Adjust settings as desired and record to the same User Memory button using the steps given in “Change and record massage programs according to your preference.” on page 25.

Erasing Recorded Data

1. Turn on the power.

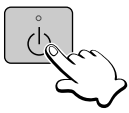

2. Press the button corresponding to the data you wish to delete.

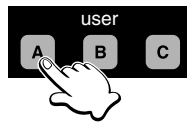

Only the button pressed lights up.



3. When the Program Selection buttons light up...

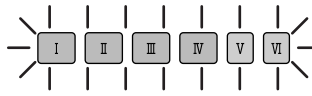

Press the same button again and hold for 3 or more seconds.

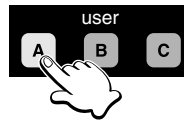

Flashing

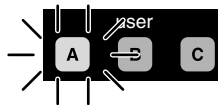

4. Press the button once again while it is flashing.

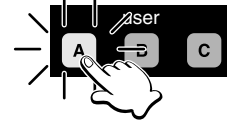

Change to steady light indicates completion.



Additional Information

About the Focus Function

Number of Times an Action Is Repeated

- Action in progress when the Focus button is pressed is repeated twice. (The duration of the program will not be extended.)

Memory Available for Recording Repeated Actions

- Eight repeated actions can be memorized.
- After 8 actions, new ones are recorded by overwriting the oldest action in memory.

The pre-program messages were created based on massages practiced by professional massage therapists in accordance with the aim of each program. The user memory function preserves the basic massage actions of these programs and allows them to be used as a base upon which to build personalized massages. For this reason, the maximum number of repeated actions that may be recorded is eight, so that a massage cannot be focused on one area of the body. Please use either the self program or manual operation when you want a massage that focuses on a particular area of the body.

Additional Information

About the Massage Position Adjustment Function

Range of Roller Position button

Vertical or lateral adjustment by pressing up to 2 times in any direction (up, down, left or right)

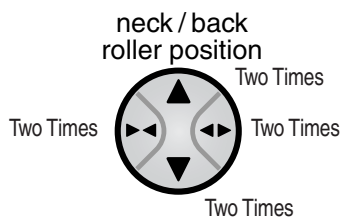

The above adjustments cannot be made in the case of certain massage actions or massage on certain of the body.

Adjustable Range

Vertical movement: 0.9 in. (2.4 cm) (up and down)
Lateral movement: 0.4 in (1.0 cm) (left and right)

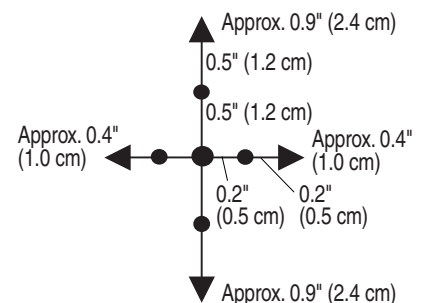
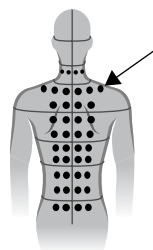

USING MANUAL OPERATION (Upper Body)

Recommended for focused massage using preferred actions on specific parts of the body.

Manual Operation for Massage of the Upper Body

Please open the controller cover to use in manual operation.

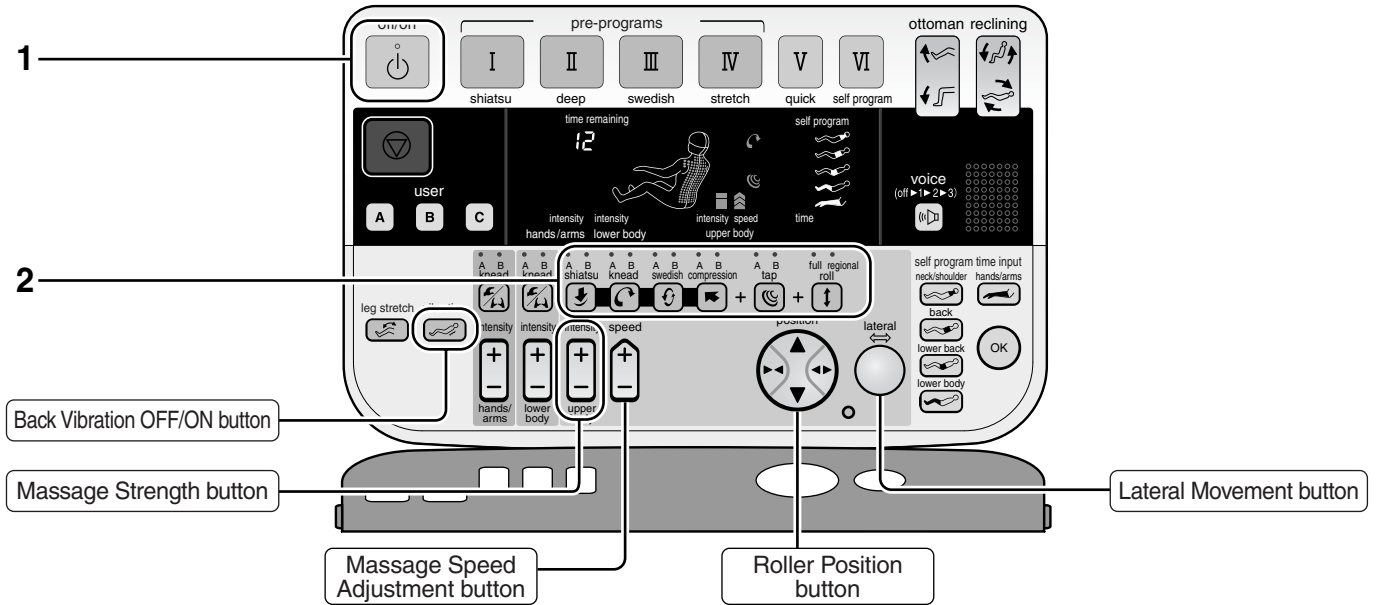

1. Press to turn on the power.

2. Select your massage action of preference.

Selection of Massage Actions

- The LED above the selected massage will light up.
- The icon of the button pressed will light up on the display.
- Massage actions are combinable. (Massage actions indicated by the area in chart below cannot be combined with one another.)

	Shiatsu	Kneading	Swedish	Compression	Tapping	Rolling
Pressed One Time	Shiatsu A	Knead A	Swedish A	Compression A	Tap A	Full
Pressed Two Times	Shiatsu B	Knead B	Swedish B	Compression B	Tap B	Regional
Pressed Three Times	<ul style="list-style-type: none"> • An action combined with another can be toggled off by pressing its button. • An action being used alone can be toggled back on by pressing its button once. 					

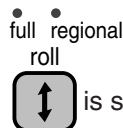

Body scanning will commence when is selected.

- When you feel a light tapping sensation on your shoulders, always check the shoulder position and when necessary adjust it manually. (See Page 16)

3. Adjust message position and strength.

(These adjustments cannot be made with the controller cover closed.)

Adjusting Message Position

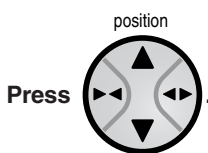

- The approximate position of the message will be shown on the Message Area Display.
- If you hold the up or down button down the message heads will continue to move until you release the button.
- In some places the strength of the message will be automatically reduced. (See Page 33)
- In some cases the message position will not immediately change even though the Roller Position button is pressed.

Adjusting Message Strength

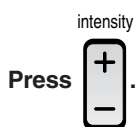

- The strength of the message is shown on the Upper Body Massage Action Display in five stages.
- In some cases the degree to which the strength of the message can be adjusted will depend on the area being massaged. (See Page 31)
- In some cases the message strength will not immediately change even though the Message Strength button is pressed.
- The strength of the back vibration function is not adjustable.

Adjusting Message Speed

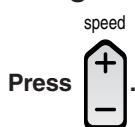

- The speed of the message is shown on the Upper Body Massage Display in five stages.
- The speed of the back vibration function is not adjustable.

Adjusting Lateral Movement

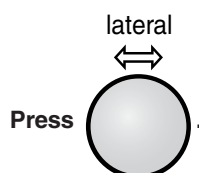

- Press this button to increase the width of the message in the location the message heads were in when you pressed the button.
- \longleftrightarrow will be shown on the display.
- In some places the strength of the message will be automatically reduced. (See Page 33)
- Back vibration cannot be combined.
- Press the button again to revert to normal massage action.

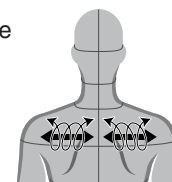

Combining with the Back Vibration

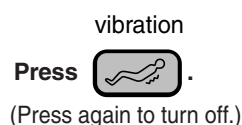

The display will indicate whether the back vibration function is turned on or off. (Lit areas indicate active functions. Unlit areas indicate inactive functions.)

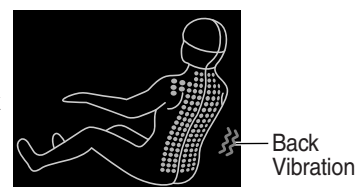

4. When the massage is finished the unit will automatically shut off.

(The massage will finish approximately 15 minutes after it starts.)

- The massage heads will retract and then stop.

USING MANUAL OPERATION (Lower Body)

Manual Operation for Massage of the Lower Body

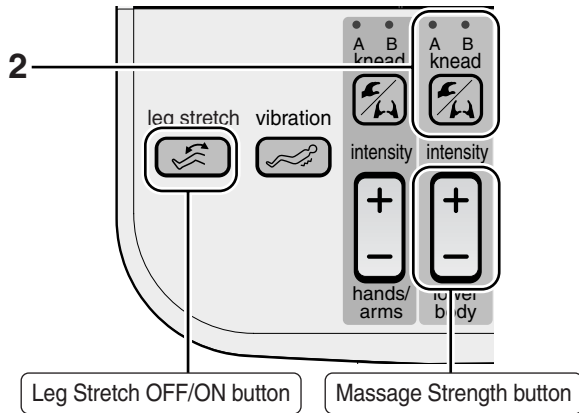

1. Press to turn on the power.

2. Select your massage action of preference.

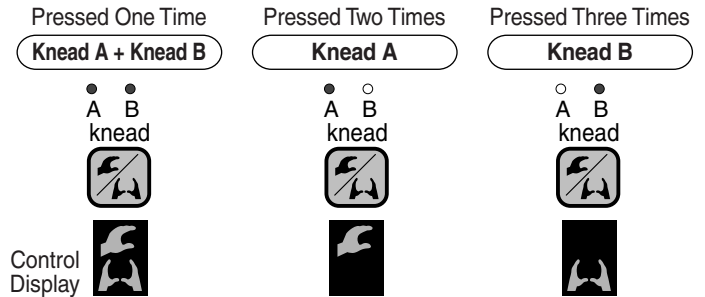

- The selected massage action may be changed to another part way through the massage. If this is done the massage will start again once the air has been released.

- Only the legrest will automatically rise to the correct massage position.

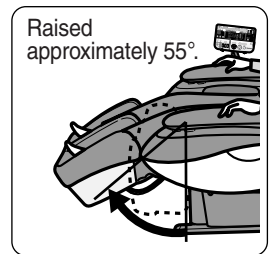

3. Adjust to your preferred level of strength.

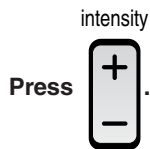

- The strength of the massage is shown on the Lower Body Massage Display in five stages.
- The massage strength can be adjusted until a "beep-beep-beep" sound is heard.
- The strength of the leg stretch and back vibration functions is not adjustable.

Combining with the Leg Stretch Function



The display will indicate whether the leg stretch function is turned on or off.
(Lit areas indicate active functions. Unlit areas indicate inactive functions.)



4. When the massage is finished the unit will automatically shut off.

(The massage will finish approximately 15 minutes after it starts.)

- It will take a number of seconds for the air to be completely released. (After pressing you will hear air being released.)
- Press if you want to stop the massage during a program. Press if you want to stop the massage immediately. (See Page 18)

USING MANUAL OPERATION (Hands/Arms)

Manual Operation for Massage of the Hands/Arms

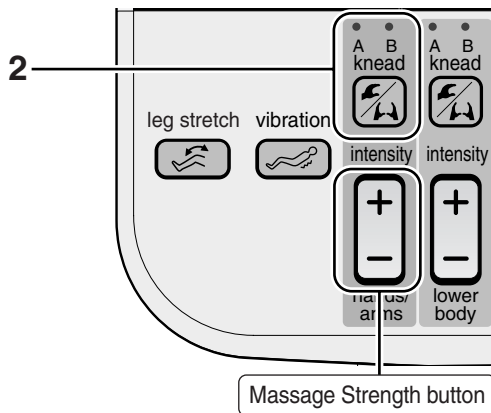

1. Press to turn on the power.

2. Select your massage action of preference.

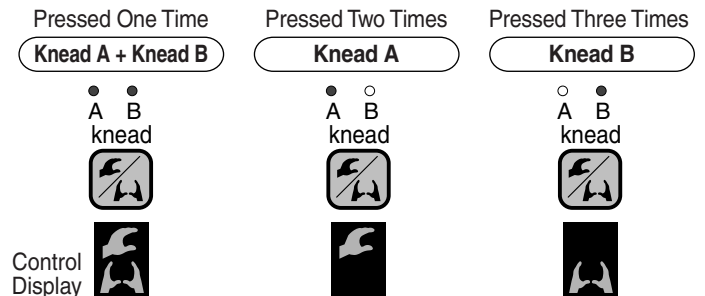

- The selected massage action may be changed to another part way through the massage. If this is done the massage will start again once the air has been released.

3. Adjust to your preferred level of strength.

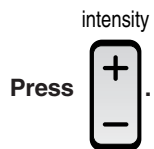

- The strength of the massage is shown on the Hand/Arm Massage Display in five stages.
- The massage strength can be adjusted until a "beep-beep-beep" sound is heard.

4. When the massage is finished the unit will automatically shut off.

(The massage will finish approximately 15 minutes after it starts.)

- It will take a number of seconds for the air to be completely released. (After pressing you will hear air being released.)
- Press if you want to stop the massage during a program. Press if you want to stop the massage immediately. (See Page 18)

Upper Body Massage Actions

Shiatsu A Uses a two-stage shiatsu action from above. Recommended for those with severe shoulder stiffness.

Shiatsu B Uses a three-stage shiatsu action that gradually increases in strength. Recommended for those with severe lower-back stiffness.

Knead A Kneads from the outside to the center of the back. Recommended for massage of the area between the neck and shoulder blades.

Knead B Kneads from the center to the outside of the back. Recommended for massage of the lower back.

Swedish A Uses a gentle upward rubbing action. Recommended for those with tired backs.

Swedish B Uses a gentle downward rubbing action. Recommended for those with tired shoulders.

Compression A Stretches muscles using an upward pressing action. Recommended for moderate stretching of the back.

Compression B Stretches muscles using an outward pressing action. Recommended for moderate stretching of the area between the shoulder blades.

Tap A Uses a strong tapping action. Recommended for thorough loosening of muscle stiffness.

Tap B Uses a gentle tapping action. Recommended for pleasant loosening of muscle stiffness.

Full Roll Stretches out muscles along the spine. Recommended for stretching the entire length of the spine from the lower back to the neck.

Regional Roll Stretches out localized areas along the spine. Recommended for focused stretching on a portion of the muscles along the spine.

Back Vibration Vibrates intermittently at a high rate of oscillation. Recommended in combination with Full Roll for relaxation of the entire body.

USING MANUAL OPERATION

Additional Information

How to Get the Most Out of Your Massage Lounger

- (1) Start with a rolling massage only to allow your body to get used to the massage lounger.
- (2) Next use a kneading or tapping massage in areas surrounding stiff muscles.
- (3) Finish with a rolling massage to stretch your spine again.

About Massage Strength Adjustments

- For the purposes of safety, limits have been set on the maximum degree to which the massage heads can protrude into the back during an upper body massage. For this reason, the levels to which massage strength can be adjusted are dependent on the area of the back being massaged and the type of massage action being used.

	Area (A)	Area (B)	Area (C)
Compression A	Up to strength level 2	Adjustable past strength level 5. (Display shows level 5 even when adjusted past that point.)	Up to strength level 4
Shiatsu A, Shiatsu B, Knead A, Knead B, Compression B	Up to strength level 3		Up to strength level 5
Swedish A, Swedish B, Tap A, Tap B, Back Vibration	Up to strength level 5		
Full Roll, Regional Roll	Up to strength level 3	These areas not massaged.	

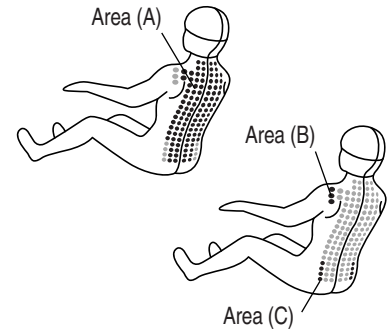

- When massage actions are combined, massage strength is adjustable to the level of the selected massage action with the lowest strength level.
- When combined with lateral movement, Compression A is adjustable to strength level 2 and other massage actions are adjustable up to strength level 3.

Rolling Massage

- When a massage is being carried out over a wide area, if Roll is selected, then the width of the massage will automatically be reduced before the Roll massage begins.

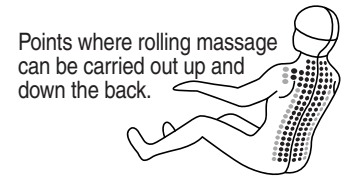

Upper Body Massage Adjustment

- The scope of the massage heads depending on the type of massage selected is shown below.

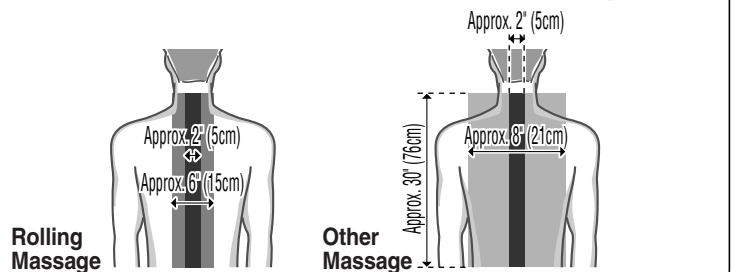

About the Leg Stretch Action

- (1) After the seat, thighs and the whole of the legs have been grasped by the airbags, they are given a light stretch as the legrest lowers approximately 10 degrees.

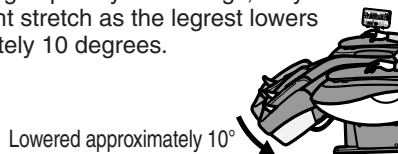

- (2) The legrest rises to its starting position, after which it lowers again, but this time approximately 20 degrees for a deep stretch.



- (3) The legrest returns to its original angle.

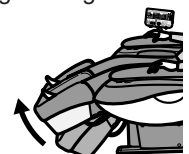

Massage Actions (Lower Body)



- After applying pressure to the sides and backs of the legs, pressure is applied to relax muscles using a rhythmic action that moves in order of the calves, the thighs and the seat.
- This kind of massage is ideal after exercising when your muscles feel tired.



- After applying pressure to the sides and backs of the legs, pressure is applied to the calves and they are slowly squeezed from the bottom up.
- This kind of massage is ideal for preventing swelling in the lower body.

Massage Actions (Hands/Arms)



- After the hands have been grasped, the muscles in the forearms are relaxed in a rhythmic manner.
- This kind of massage is ideal after exercising when your muscles feel tired.



- The area from the hands to forearms is slowly and thoroughly squeezed.
- This kind of massage is ideal when your arms feel heavy due to poor circulation.

AFTER COMPLETING THE MASSAGE

Return the Seat to the Original Position

1. Check that nothing is under the legrest and that air is being released.



2. Always return the legrest to its original length if it has been slid out.

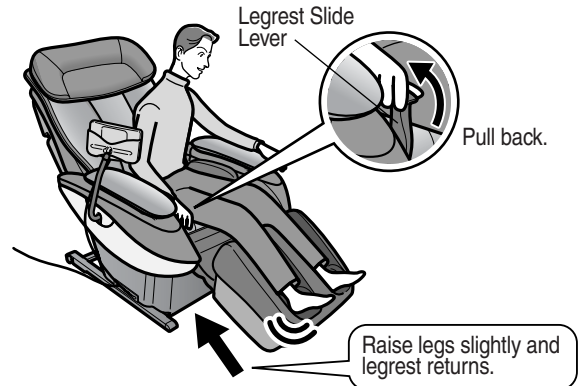

3. Press  twice to return the chair to the upright position.



4. If the pillow or back cushion has been flipped back or the control panel has been removed from its stand, return them to their original positions.

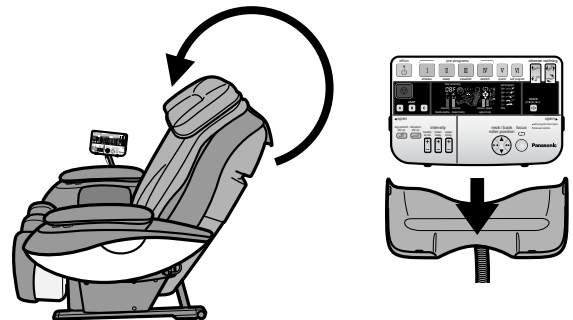

Disconnect the Power

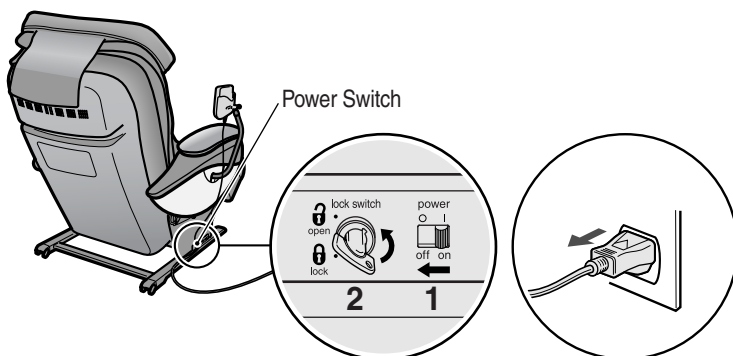

1. Slide the power switch to the “off” position.

2. Turn the lock switch key to the “lock” position.

* Remove key and store out of reach of children.

3. Unplug the power cord.

CLEANING AND MAINTENANCE

CAUTION

- Always unplug the unit before cleaning it. Never touch a power plug with wet hands. Failure to follow these instructions may lead to electrocution or burns.

Areas Covered with Synthetic Leather

- Wipe these areas with a soft, dry cloth. (Do NOT use cloths containing any kind of chemical, etc.)
- If the synthetic leather is particularly dirty, soak a soft cloth in water or a 3-5% solution of mild detergent, wring it out thoroughly and tap the surface with it. Next, rinse the cloth in water, wring it out thoroughly and then wipe any remaining detergent from the surface, wipe the surfaces with a soft dry cloth and allow them to dry naturally. (Do NOT use a hair dryer to try to dry the surfaces more quickly.)



- Do not allow these areas to come in contact with plastic for extended periods of time as this may lead to discoloration.

Pipe and Plastic Areas

- (1) Wipe the unit with a cloth that has been soaked in a mild detergent and then thoroughly wrung out.
 - (2) Next wipe the unit with a cloth that has been moistened with just water and thoroughly wrung out.
 - * Make sure you thoroughly wring out the cloth first when cleaning the control panel.
 - (3) Allow the unit to dry naturally.
- Please do NOT use thinners, benzine or alcohol.

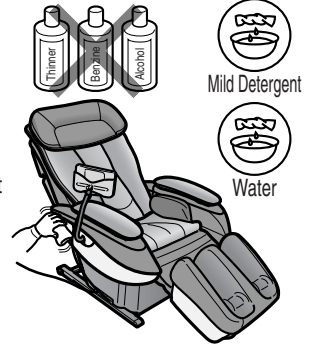

Seat Fabric

- (1) Wipe the seat fabric with a cloth that has been soaked in a mild detergent and then thoroughly wrung out.
- (2) Use a mild detergent and brush on areas where the seat fabric has become particularly soiled. Be careful not to brush the fabric too much as you may damage it.
- (3) Next wipe the fabric with a cloth that has been moistened with just water and thoroughly wrung out.
- (4) Allow the fabric to dry naturally.



Moving the Unit

CAUTION

- Do not move the unit while someone is seated on it. Do not place objects on or sit, climb, or stand on the legrest.
- When moving the unit using the wheels, remove all obstacles from around it, make sure the backrest is in the upright position, lift it no higher than waist height (no higher than 31 in. (80 cm)) and roll it slowly. Failure to do so may cause the unit to tip over, which may lead to damage or injury.

Lifting the Unit

- Move the chair by having one person hold onto the rubber section on the underside of the legrest and another person use the handle on the back of the backrest.
- * Please hold the handle and legrest securely to avoid dropping the unit as it may damage your floor.

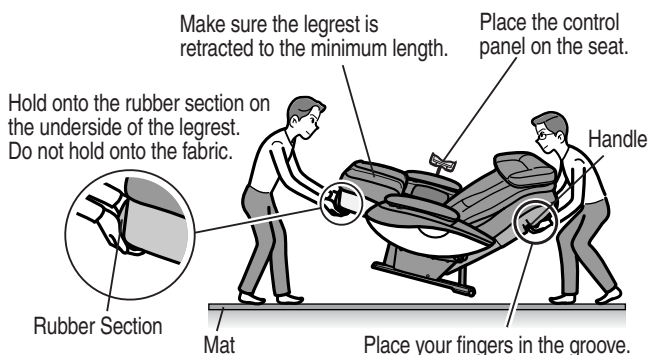

Using the Wheels to Move the Unit

- Move the chair by holding onto the rubber section on the underside of the legrest and using the wheels. (It is easier to move the unit when the massage heads are positioned at the top of the backrest.)
- * Place a mat on the floor and gently roll the unit over it to avoid damaging the floor.

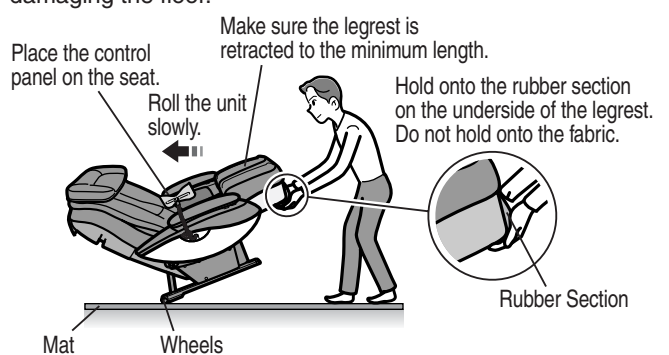

ABOUT THE BODY SCANNING FUNCTION

Additional Information

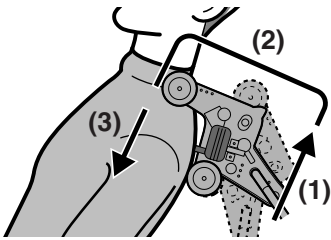

(4) Soft Tapping

Body Scanning

- (1) As the electronic tone that accompanies the body search function sounds, the massage heads will rise up the back until they reach the area behind the neck.
- ↓
- (2) The massage heads will tilt forward so that they are positioned over the shoulders. (If the shoulder position is incorrect the massage heads will rise again and then repeat the shoulder alignment movement.)
- ↓
- (3) The massage heads will descend to the level of the shoulders.
- ↓
- (4) A soft tapping massage is performed at the level of the shoulders, which lasts for approximately 15 seconds.

When the Body Scanning Function is Not Completed Successfully

- A recorded voice message will announce, “In the interests of safety, the massage will now finish because an occupant could not be detected in the chair.” during the body scanning.

This may occur in the following situations:

1. Pressure against the backrest cannot be detected because no one is sitting in the chair.
2. Pressure against the backrest cannot be detected because the occupant’s head and back are not touching the backrest.
3. Pressure against the backrest cannot be detected because the occupant is wearing heavy clothing or an object such as a cushion has been placed between the occupant’s back and the backrest.

Sit as far back in the seat with your head on the pillow and press  again to start the body scanning.

When the Soft Tapping Massage Does Not Start

- If the body scanning is performed at the highest height, it will stop for a few seconds and the soft tapping massage will not be carried out.

To adjust the shoulder position, do so after the massage has begun.

When Changing the Occupant in the Middle of a Massage

- Press  once to finish the massage then start again as the shoulder position will change.

Additional Information

Pressure Feedback Function

The strength of the massage (pressure level) is automatically adjusted if it is too much or too little.





- The standard body pressure level varies according to the strength of the program selected.
- If you lift your back or stand up in the middle of a massage, the body pressure level detected will be zero thus causing the massage to finish.

Pressure Feedback in Shoulder Area

- When a massage program is used, the body pressure level at the top of the shoulders is detected just before the start of a massage at the top of the shoulders. If the body pressure level is different from that of the previous massage a soft tapping massage will begin.

TROUBLESHOOTING

PROBLEM	
Problem	Cause and Remedy
<p>Motor Noises</p> <ul style="list-style-type: none"> • It sounds and feels like the massage heads are straining to get over wrinkles in the cloth. • The motor groans when it comes under load. • There is excessive noise during Tapping. (The noise is greater at the top of the massage lounger.) • There is a creaking noise when the massage heads are in operation. • There is a sound when the vibration action is selected. • There is a rattling sound when the massage heads move up or down. • The belt can be heard rotating. • There is a rubbing sound produced by the massage heads rubbing on the seat fabric. • There is a noise when the back cushion moves over the armrest when the seat is reclining. • There is a noise when I sit down. • There is a strange sound when the massage heads move in and out. • When the power switch is turned on there is a humming sound. • Air massage-related sounds. There is a hissing sound of air escaping. There is a humming sound from the pump. • The legrest rattles. • There is an unstable sound when air escapes during the leg stretch. 	<p>▶ These sounds are perfectly normal and will not have any effect on the operation of the unit.</p>
<p>The massage heads stop during operation.</p>	<p>▶ <u>If excessive force is applied to the massage heads during operation, in the interests of safety the massage heads may stop moving.</u> If all markings and buttons on the control panel start to flash, which is extremely unusual, turn off the power switch, wait for approximately 10 seconds and then turn the power switch on again. If the massage heads stop again, position yourself so that your back is not completely in contact with the backrest.</p>
<p>The massage heads do not come up to the shoulder or neck.</p>	<p>▶ The position of the massage heads is incorrect. (See Page 16)</p>
<p>The height of the left and right massage heads is different.</p>	<p>▶ An alternating tapping method is employed, which means that this phenomenon will naturally occur. There is nothing wrong with the unit.</p>
<p>The air in the seat is not being released.</p>	<p>▶ If the power cord is unplugged or there is a power outage while air massage is being carried out, the air will be trapped in the unit. The air will automatically be released when the power cord is plugged back in again (or when the power comes back on).</p>
<p>It is not possible to recline the unit. The legrest cannot be raised or lowered.</p>	<p>▶ <u>If the unit encounters an obstacle or if excessive force is exerted on it during operation, in the interests of safety the unit will come to a stop.</u> If all markings and buttons on the control panel start to flash, which is extremely unusual, turn off the power switch, wait for approximately 10 seconds and then turn the power switch on again.</p>

Problem	Cause and Remedy
Reclining does not take place even though a massage is started in pre-programs. (The seat does not automatically recline.)	▶ In some cases the seat may not automatically recline depending on the position (angle) of the backrest or the legrest.
The backrest does not return to the upright position.	▶ The backrest will not return to the upright position if the timer is activated or the  button is pressed. (Pressing  twice will return the backrest to its original position.)
The legrest does not go down.	▶ The legrest will not go down properly if the legrest slide has been extended. Try again after retracting it.
The unit will not operate at all. <ul style="list-style-type: none"> • Upper body (neck to lower back) massage. • Lower body (calves to seat) massage. 	▶ <ul style="list-style-type: none"> • The power cord has been disconnected. (See Page 11) • The power switch on the unit has not been turned on. (See Page 11) • A Pre-Program button or Manual Operation button hasn't been pressed after pressing . (See Pages 11, 15, 19, 22, 25)
The arm massage does not work.	▶ <ul style="list-style-type: none"> • The power cord has been disconnected. (See Page 11) • The power switch on the unit has not been turned on. (See Page 11) • A Pre-Program button or Manual Operation button hasn't been pressed after pressing . (See Pages 15, 21, 27, 33) • The air plug is not properly connected or disconnected. (See Page 9)
The unit has been damaged.	▶ Stop using the unit immediately.
The power cord or power plug is abnormally hot.	▶ Stop using the unit immediately.

SPECIFICATIONS

Power Supply:	AC120V 60Hz
Power Consumption:	210 W
Upper Body Massage	
Massage Area (Up-Down):	Approx. 30 in. (76 cm)
Massage Area (Left-Right):	Distance between Massage Heads during Operation Neck, Shoulder, Back, Lower Back: Approx. 2 – 8 in. (5 – 21 cm)
Massage Area (Forward-Back):	Approx. 4 in. (10 cm)
Maximum Total Massage Surface:	Approx. 188 sq. in. (1,216 cm ²)
Up-Down Movement Speed:	Approx. 19 – 92 sec. return.
Massage Speed:	Knead A, B: Approx. 11 – 20 cycles/min. Tap: Approx. 240 – 550 sec. (one way)
Lateral/Vertical Travel:	Lateral Travel: Approx. 5 cm left-right auto return Vertical Travel (Long): Approx. 30 in. (76 cm) up-down auto return Vertical Travel (Short): Approx. 4 in. (10 cm) up-down auto return
Massage Width:	Rolling, Vertical Movement: Approx. 2 – 6 in. (5 – 15 cm) Other than the above: Same as massage area (left-right).
Hand/Arm Massage	
Air Pressure:	Strong: Approx. 33.5 kPa Medium: Approx. 26.0 kPa Weak: Approx. 15.5 kPa
Sole/Calf/Seat Massage	
Air Pressure:	Sole/Calf Areas: Strong: Approx. 33.5 kPa Medium: Approx. 26.5 kPa Weak: Approx. 16.5 kPa Seat/Thigh Areas: Strong: Approx. 29.5 kPa Medium: Approx. 22.0 kPa Weak: Approx. 13.5 kPa
Reclining Angle:	Backrest: Approx. 120° – 170° Legrest: Approx. 0° – 85°
Automatic Shut-Off:	Approx. 15 min. for both upper and lower body
Dimensions:	
When not reclined. (H × W × D)	45.3 × 33.1 × 50.8 in. (115 × 84 × 129 cm)
When reclined. (H × W × D)	22.4 × 33.1 × 77.6 in. (57 × 84 × 197 cm)
Weight of Unit:	Approx. 179 lbs (81 kg)
Dimensions of Box (H × W × D):	30.7 × 30.7 × 65.4 in. (78.0 × 78.0 × 166.0 cm)
Weight in Box:	Approx. 218 lbs (99 kg)
Maximum User Weight:	264 lbs (120 kg)
Minimum Distance from Wall:	15.7 in. (40 cm)

**Panasonic Consumer
Electronics Company**

One Panasonic Way 4A-3
Secaucus, New Jersey 07094
1-800-338-0552 for questions and comments.
www.panasonic.com/massage